



Meta-MEC
**Mini Contactors and
Overload Relays**

**Customer satisfaction with world-class
products and services :
LSIS is committed to excellence!**

**We are committed to global product development,
driving future growth, and expanding
the overseas market share, as well as consolidating
existing business. Join us in a future where LSIS will
become a genuine global leader.**

Con



Contents



Features	04	Mini contactors, Reversing type	17
Catalog numbering system	10	Bimetallic style Overload Relays	21
Quick selection table	11	Contactors relays	23
AC coil	12	Auxiliary contact	25
DC coil	14	Accessories	27
Motor starters, open	16	Dimensions	32

contactors and Overload Relays



Compact & Space Saving

LS Mini contactors & starters



LS Mini contactors and starters are suitable for the switching and protection of small motors up to 7.5kW, lights and electric heating circuits. KEMA type tested as the global product that meets international standards such as UL, CCC, Safe Certification and CE.



LS Mini -contactors and starters

Suitable for the switching and protection of motors, capacitor banks, lights, etc. in AC circuit.

Providing the convenience of connection and mounting by terminal options such as Cage clamp, Fast-on, Solder pin as well as Screw Terminal. In addition dedicated thermal style overload relays can be easily attached for motor protection and various accessories are also available - surge unit, timer unit, auxiliary contact unit.

Can be driven from the output of PLC :
low power consumption type contactor is available for this purpose, which requires no relay between contactor and PLC.



Contactors

Environmental conditions

- Ambient temperature: -5 ~ 40°C (standard 20°C)
- Max. temp. inside a panel: 55°C
- Relative humidity: 45 ~ 85% RH
- Altitude: max. 2,000m
- Vibration: 10 ~ 55Hz, 2g
- Shock resistance: 5g
- Storage temperature: -30 ~ 65°C

Reference standards

- IEC 60947-4
- UL 508

Certification

- ISO 9001, ISO 14001
- UL, CE, safety certification, CCC



Low Consumption

The low power consumption type contactor, a product that combines the advantages of the relay and the magnetic contactor, can be driven directly by the small output of the PLC. The relay and its space in the panel are not necessary any more.

Direct driving by

- PLC output contact
- Photoelectric switch, proximity switch . . .
- Transistor output of various detection



AC 380V
7.5kW
16A
or under

Direct driving by PLC output

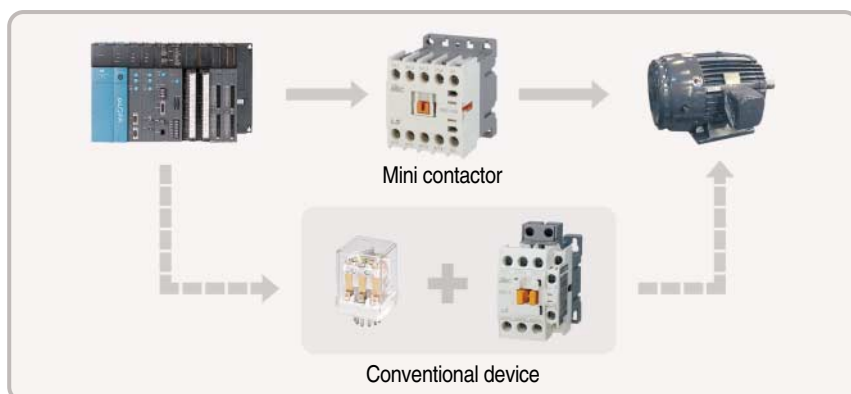

Low-power consumption type

Directly operable by the low output signal from the devices such as PLC, photoelectric switches and proximity limit switches, etc.

So the driving of 3-phase induction motor can be done without using an intermediate relay .



PLC



Remote I/O unit

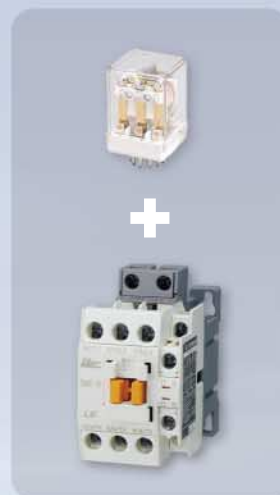

Conventional style
(Relay + Contactor)



Inverter



Servo motor operation



Lighting circuits



Reduction rate of power consumption

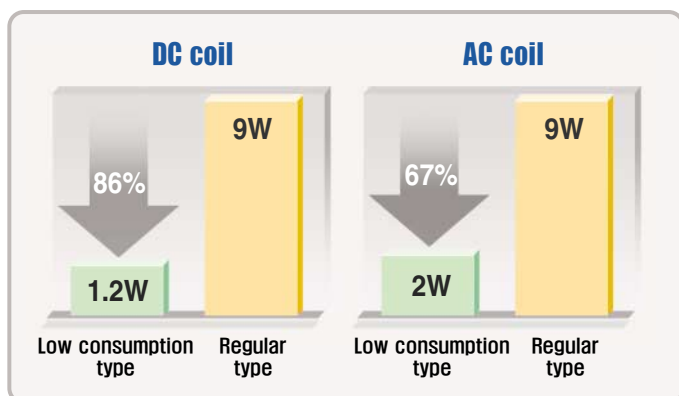

Characteristic of control coil

Coil Type	AC coil (50/60Hz)	DC			
		Regular	Wide	Low consumption	
Power consumption (W)	2	3	2	1.2	
Control voltage (V)	24~550	12~250	12, 20, 24, 48, 72, 110, 120	12, 20, 24, 48, 72, 110, 120	
Operation voltage (%)	Pick-up	80 or under	75 or under	70 or under	75 or under
	Release	30 or over	12 or over	12 or over	12 or over
Operation time (ms)	Coil ON →	20 or under	50 or under	50 or under	50 or under
	Contact ON	20 or under	50 or under	50 or under	50 or under
	Coil OFF →	45 or under	45 or under	45 or under	45 or under
	Contact OFF	45 or under	45 or under	45 or under	45 or under

Convenience

4 terminal options for a variety of applications

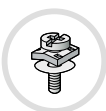
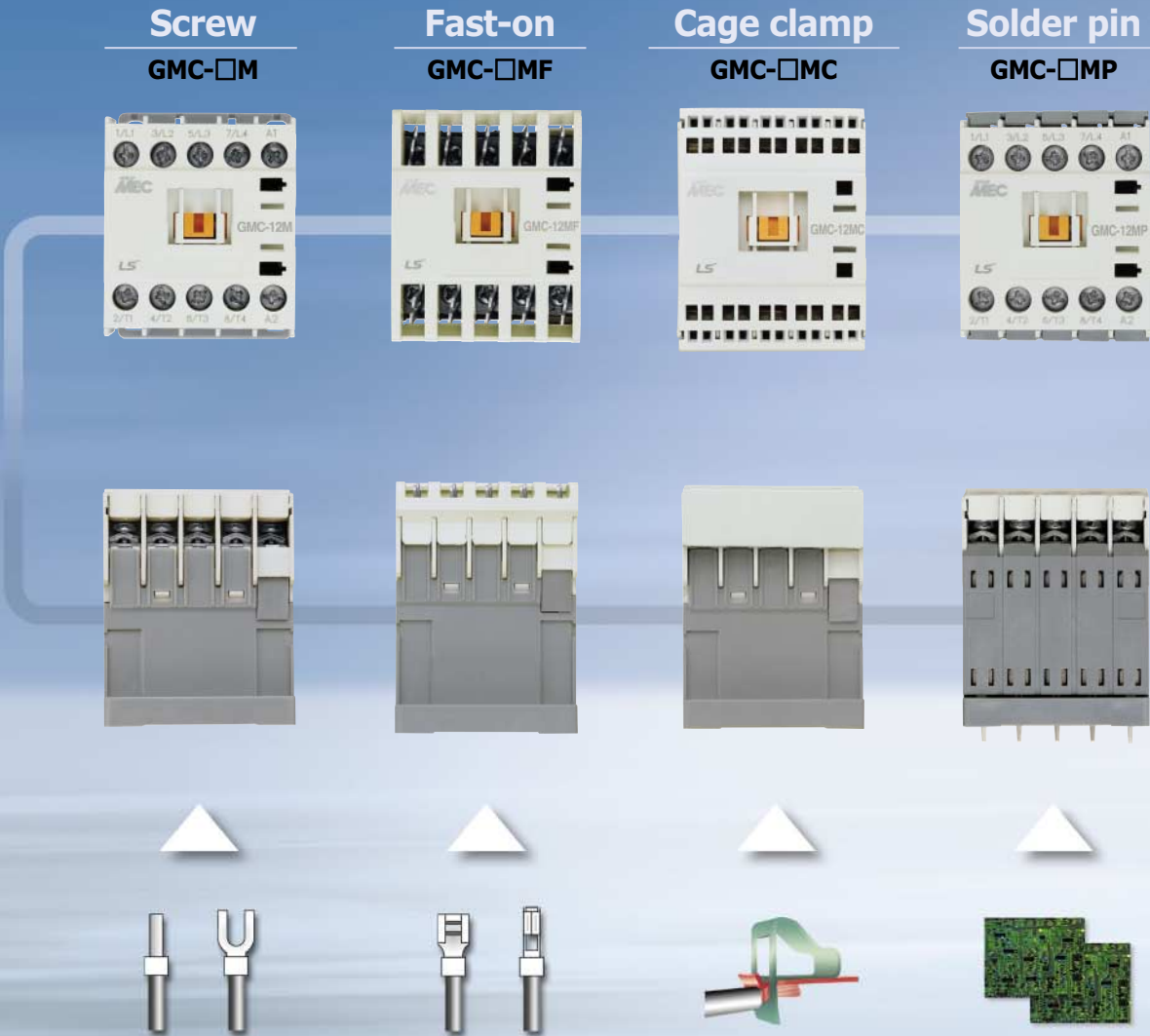

Screw terminal

Standard type with M3 screw for connection with a ring or U type terminal



Fast-on terminal

Plug-in style for connection with a quick-connector. (2.8 × 0.8t/6.3 × 0.8t common)

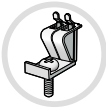

Cage clamp terminal

suitable for connection with wires directly



Solder pin terminal

for mounting on PCB

Auxiliary contact units

Item	Screw	Fast-on	Cage clamp	Solder pin
Side mount				
2-p, Front mount				×
4-p, Front mount				×

Variety

Accessories ...

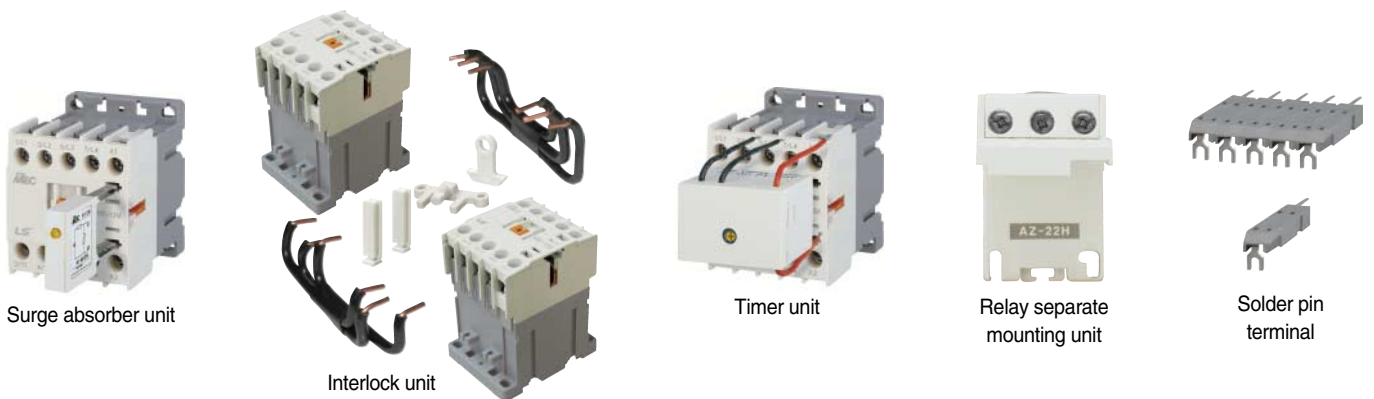
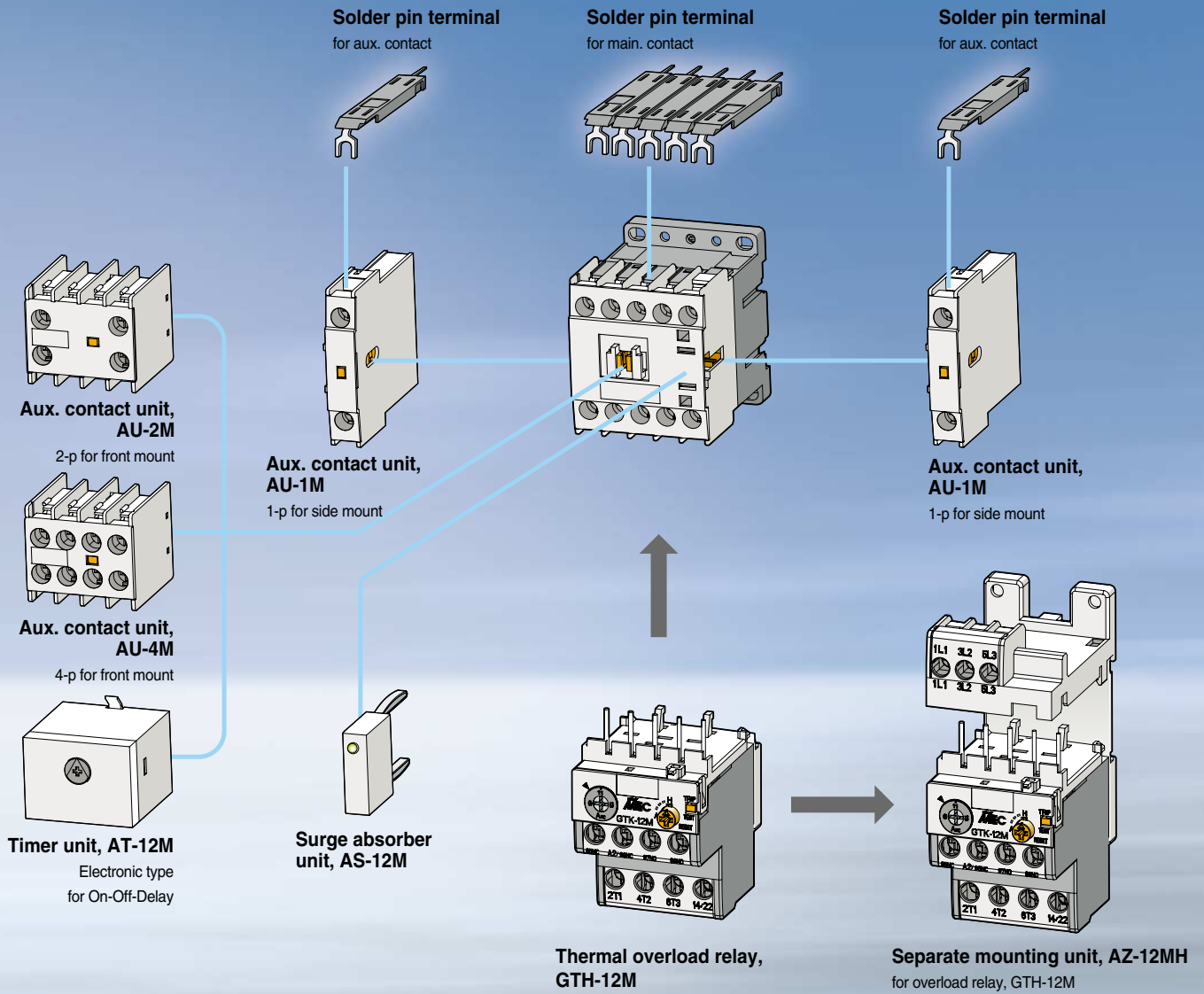

Catalog numbering system

Contactor & Starters

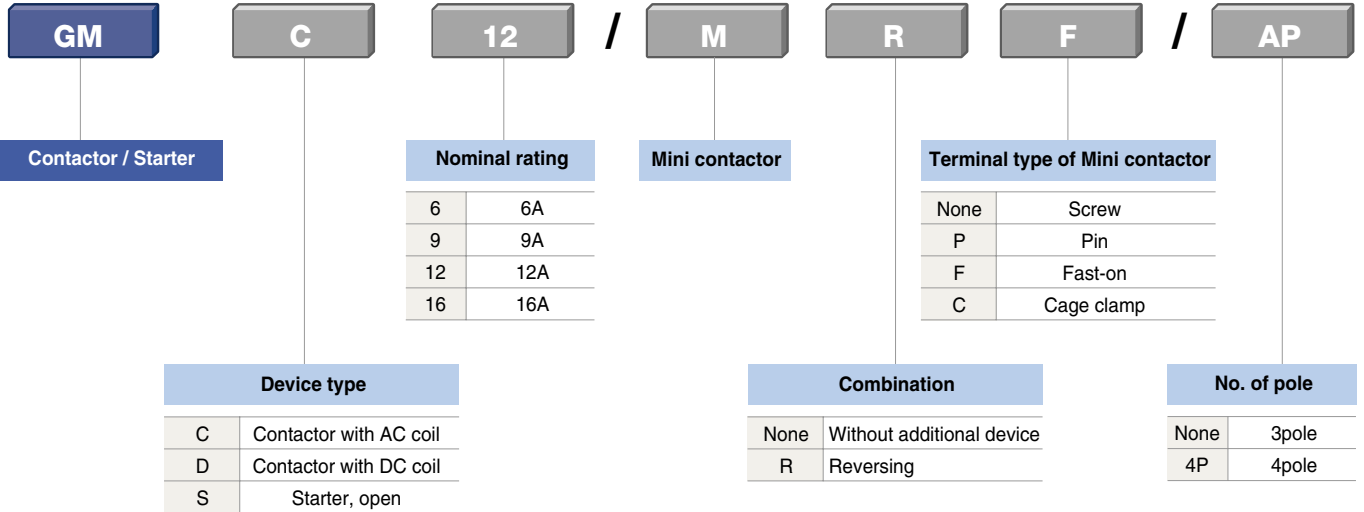

Thermal overload relay

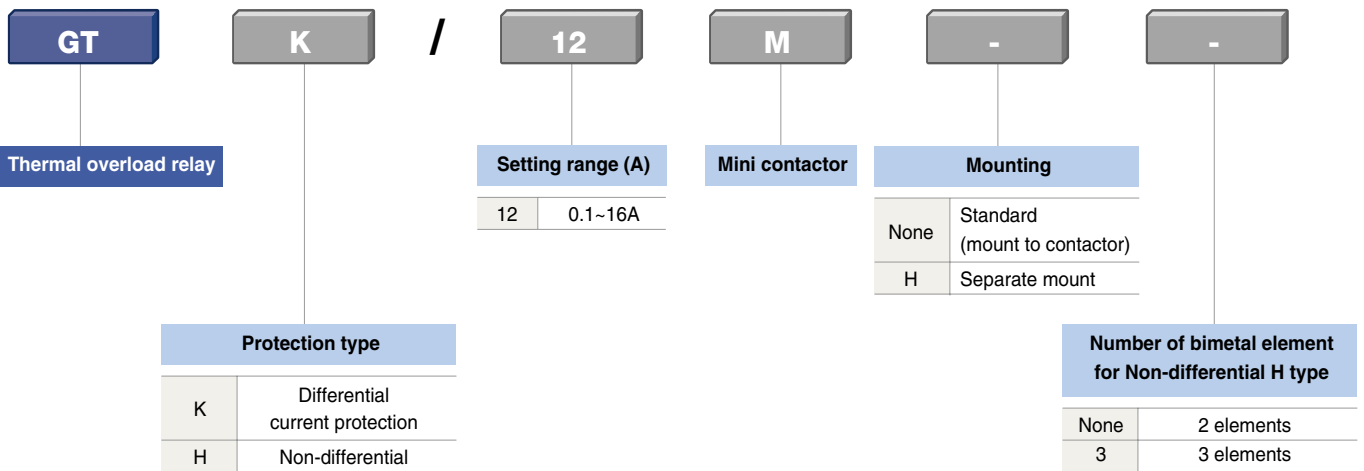

2-pole Contactors

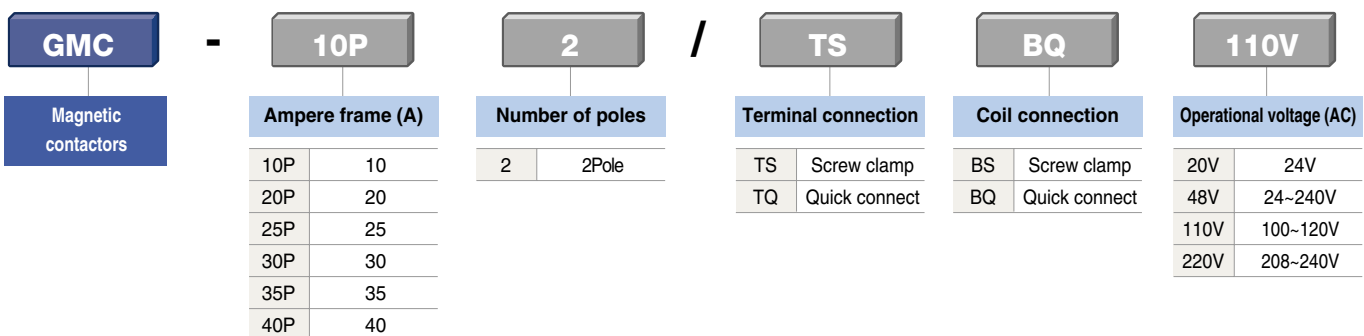

Quick selection table

Mini contactors

3NO main contacts
1 auxiliary contacts



Screw clamp type



Fast-on type



Cage clamp type



Solder pin type

Frame size		6A		9A		12A		16A	
Screw clamp type	AC coil	GMC-6M		GMC-9M		GMC-12M		GMC-16M	
	DC coil	GMD-6M		GMD-9M		GMD-12M		GMD-16M	
Fast-on type	AC coil	GMC-6MF		GMC-9MF		GMC-12MF		GMC-16MF	
	DC coil	GMD-6MF		GMD-9MF		GMD-12MF		GMD-16MF	
Cage clamp type	AC coil	GMC-6MC		GMC-9MC		GMC-12MC		GMC-16MC	
	DC coil	GMD-6MC		GMD-9MC		GMD-12MC		GMD-16MC	
Solder pin type	AC coil	GMC-6MP		GMC-9MP		GMC-12MP		GMC-16MP	
	DC coil	GMD-6MP		GMD-9MP		GMD-12MP		GMD-16MP	
Ratings / IEC60947-4		kW	A	kW	A	kW	A	kW	A
AC1		20		20		20		20	
AC3	200/240V	1.5	7	2.2	9	3	12	4	15
	380/440V	2.2	6	4	9	5.5	12	7.5	16
	500/550V	3	5	3.7	6	4	7	5.5	9
	690V	3	4	4	5	4	5	4	5
Ratings / UL508		hp	A	hp	A	hp	A	hp	A
continuous current		I _{th} = 20A (maximum for cage clamp type is 10A)							
single phase	120V	1/2		1/2		1 *		-	
	230V/240V	1		1.5		2 **		-	
three phase	240V	1.5		3		3		-	
	480V	3		5		7.5 ***		-	
	600V	3		5		7.5		-	
Wire Range : Copper, 75°C, Stranded, 18-12AWG									
NEMA size		00		00		00		0	
Additional auxiliary contacts		Screw clamp type		Fast-on type		Cage clamp type		Solder pin type	
2-pole, Front mount	AU-2M			AU-2MF		AU-2MC			
	AU-4M			AU-4MF		AU-4MC			
4-pole, Front mount	AU-1M			AU-1MF		AU-1MC			
2-pole, Side mount									

Note) * = 1/2 for cage clamp type, ** = 1.5hp for cage clamp type, *** = 5hp for cage clamp type
16AF : not approved from UL

Overload Relays

Bimetallic style Type GT Class 10A	 GT-12M	Setting ranges (A) 0.1 - 0.16 0.16 - 0.25 0.25 - 0.4 0.4 - 0.63 0.63 - 1 1 - 1.6 1.6 - 2.5 2.5 - 4	4 - 6 5 - 8 6 - 9 7 - 10 9 - 13 12 - 16	 Base for separate mount
	Differential	GTK-12M		
	Non-differential (3-heater)	GTH-12M/3		
	Non-differential (2-heater)	GTH-12M		

Contactors

- For motor control
- 3 main plus 1 auxiliary contacts
- Coil voltage : AC

Circuit diagram

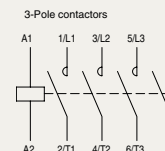

Screw clamp connection types



Frame size	AC3 ratings (IEC60947-4)				AC1 rating lth	Auxiliary contact (standard)	Type
	220 ~ 240V	380 ~ 440V	500 ~ 550V	690V			
6A	1.5kW 7A	2.2kW 6A	3kW 5A	3kW 4A	20A	1NO or 1NC	GMC-6M
9A	2.2kW 9A	4kW 9A	3.7kW 6A	4kW 5A	20A	1NO or 1NC	GMC-9M
12A	3kW 12A	5.5kW 12A	4kW 7A	4kW 5A	20A	1NO or 1NC	GMC-12M
16A	4kW 15A	7.5kW 16A	5.5kW 9A	4kW 5A	20A	1NO or 1NC	GMC-16M

Fast-on connection types



Frame size	AC3 ratings (IEC60947-4)				AC1 rating lth	Auxiliary contact (standard)	Type
	220 ~ 240V	380 ~ 440V	500 ~ 550V	690V			
6A	1.5kW 7A	2.2kW 6A	3kW 5A	3kW 4A	20A	1NO or 1NC	GMC-6MF
9A	2.2kW 9A	4kW 9A	3.7kW 6A	4kW 5A	20A	1NO or 1NC	GMC-9MF
12A	3kW 12A	5.5kW 12A	4kW 7A	4kW 5A	20A	1NO or 1NC	GMC-12MF
16A	4kW 15A	7.5kW 16A	5.5kW 9A	4kW 5A	20A	1NO or 1NC	GMC-16MF

Coil voltage, AC 50/60Hz

24, 36, 42, 48, 110, 115, 120, 127, 200 / 208, 220, 220 / 230, 230 / 240, 256, 277, 380 / 400, 400, 440, 480, 500, 550V AC

Performance (at 440VAC)

Frame size	6A	9A	12A	16A
Operation current	6A	9A	12A	16A
Making current	72A	108A	144A	180A
Breaking current	60A	90A	120A	150A
Operation cycle	1800 operations/hour			
Endurance	• Electrical : 1 mil. operations • Mechanical : 12 mil. operations			

Note) 16A frame is not UL listed item.

Coil characteristic

Coil voltage	AC
Coil consumption (W)	2
Inrush	32VA
Sealed	6VA
Closing voltage (%)	80~110
Opening voltage (%)	30~40
Closing time (ms)	10~20
Opening time (ms)	35~45

Certificate
CE, ULcUL

Contactors

- For motor control
- 3 main plus 1 auxiliary contacts
- Coil voltage : AC

Circuit diagram

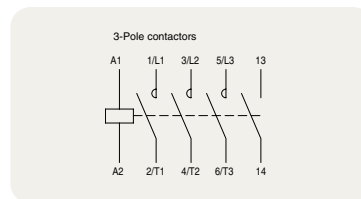

Cage clamp connection types



Frame size	AC3 ratings (IEC60947-4)				AC1 rating lth	Auxiliary contact (standard)	Type
	220 ~ 240V	380 ~ 440V	500 ~ 550V	690V			
6A	1.5kW 7A	2.2kW 6A	3kW 5A	3kW 4A	20A	1NO or 1NC	GMC-6MC
9A	2.2kW 9A	4kW 9A	3.7kW 6A	4kW 5A	20A	1NO or 1NC	GMC-9MC
12A	3kW 12A	5.5kW 12A	4kW 7A	4kW 5A	20A	1NO or 1NC	GMC-12MC
16A	4kW 15A	7.5kW 16A	5.5kW 9A	4kW 5A	20A	1NO or 1NC	GMC-16MC

Solder pin connection types



Frame size	AC3 ratings (IEC60947-4)				AC1 rating lth	Auxiliary contact (standard)	Type
	220 ~ 240V	380 ~ 440V	500 ~ 550V	690V			
6A	1.5kW 7A	2.2kW 6A	3kW 5A	3kW 4A	20A	1NO or 1NC	GMC-6MP
9A	2.2kW 9A	4kW 9A	3.7kW 6A	4kW 5A	20A	1NO or 1NC	GMC-9MP
12A	3kW 12A	5.5kW 12A	4kW 7A	4kW 5A	20A	1NO or 1NC	GMC-12MP
16A	4kW 15A	7.5kW 16A	5.5kW 9A	4kW 5A	20A	1NO or 1NC	GMC-16MP

Coil voltage, AC 50/60Hz

24, 36, 42, 48, 110, 115, 120, 127, 200 / 208, 220, 220 / 230, 230 / 240, 256, 277, 380 / 400, 400, 440, 480, 500, 550V AC

Ordering information

Type, Auxiliary contact and Coil voltage

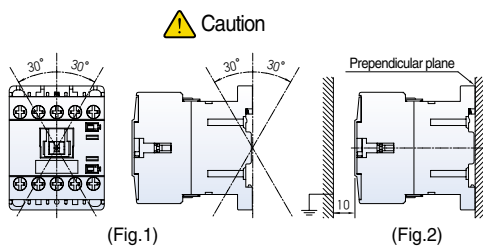

Caution

(Fig.1)

(Fig.2)

Certificate
CE, ULcUL

*Even installing direction takes the direction of Fig.1 to perpendicular, ip to the direction of the 30°.
Keep the distance more than 10mm with arc space shown Fig.2

DC coil

Contactors

- For motor control
- 3 main plus 1 auxiliary contacts
- Coil voltage : DC

Circuit diagram

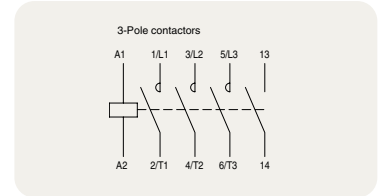

Screw clamp connection types



Frame size	AC3 ratings (IEC60947-4)				AC1 rating Ith	Auxiliary contact (standard)	Type
	220 ~ 240V	380 ~ 440V	500 ~ 550V	690V			
6A	1.5kW 7A	2.2kW 6A	3kW 5A	3kW 4A	20A	1NO or 1NC	GMD-6M
9A	2.2kW 9A	4kW 9A	3.7kW 6A	4kW 5A	20A	1NO or 1NC	GMD-9M
12A	3kW 12A	5.5kW 12A	4kW 7A	4kW 5A	20A	1NO or 1NC	GMD-12M
16A	4kW 15A	7.5kW 16A	5.5kW 9A	4kW 5A	20A	1NO or 1NC	GMD-16M

Fast-on connection types



Frame size	AC3 ratings (IEC60947-4)				AC1 rating Ith	Auxiliary contact (standard)	Type
	220 ~ 240V	380 ~ 440V	500 ~ 550V	690V			
6A	1.5kW 7A	2.2kW 6A	3kW 5A	3kW 4A	20A	1NO or 1NC	GMD-6MF
9A	2.2kW 9A	4kW 9A	3.7kW 6A	4kW 5A	20A	1NO or 1NC	GMD-9MF
12A	3kW 12A	5.5kW 12A	4kW 7A	4kW 5A	20A	1NO or 1NC	GMD-12MF
16A	4kW 15A	7.5kW 16A	5.5kW 9A	4kW 5A	20A	1NO or 1NC	GMD-16MF

Coil voltage, DC

- ① Standard type : 12, 20, 24, 36, 42, 48, 60, 72, 110, 120, 125, 220, 240, 250V DC
- ② Low consumption type : 12, 20, 24, 48, 72, 110, 120V DC(Low)
- ③ Wide Voltage : 12, 20, 24, 48, 72, 110, 12V DC(Wide)

Ordering information

Type, Auxiliary contact and Coil voltage

Coil characteristic

Coil voltage	DC		
	Standard	Low consumption	Wide voltage
Coil consumption (W)	3	1.2	2
Inrush	3W	1.2W	2W
Sealed	3W	1.2W	2W
Closing voltage (%)	80~110	80~125	70~125
Opening voltage (%)	10~30	10~30	10~30
Closing time (ms)	40~50	40~50	40~50
Opening time (ms)	35~45	35~45	35~45

Certificate
CE, ULcUL

Contactors

- For motor control
- 3 main plus 1 auxiliary contacts
- Coil voltage : DC

Circuit diagram

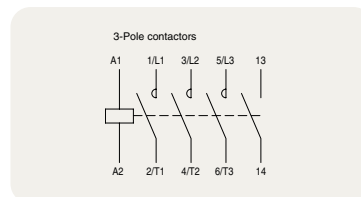

Cage clamp connection types



Frame size	AC3 ratings (IEC60947-4)				AC1 rating Ith	Auxiliary contact (standard)	Type
	220 ~ 240V	380 ~ 440V	500 ~ 550V	690V			
6A	1.5kW 7A	2.2kW 6A	3kW 5A	3kW 4A	20A	1NO or 1NC	GMD-6MC
9A	2.2kW 9A	4kW 9A	3.7kW 6A	4kW 5A	20A	1NO or 1NC	GMD-9MC
12A	3kW 12A	5.5kW 12A	4kW 7A	4kW 5A	20A	1NO or 1NC	GMD-12MC
16A	4kW 15A	7.5kW 16A	5.5kW 9A	4kW 5A	20A	1NO or 1NC	GMD-16MC

Solder pin connection types



Frame size	AC3 ratings (IEC60947-4)				AC1 rating Ith	Auxiliary contact (standard)	Type
	220 ~ 240V	380 ~ 440V	500 ~ 550V	690V			
6A	1.5kW 7A	2.2kW 6A	3kW 5A	3kW 4A	20A	1NO or 1NC	GMD-6MP
9A	2.2kW 9A	4kW 9A	3.7kW 6A	4kW 5A	20A	1NO or 1NC	GMD-9MP
12A	3kW 12A	5.5kW 12A	4kW 7A	4kW 5A	20A	1NO or 1NC	GMD-12MP
16A	4kW 15A	7.5kW 16A	5.5kW 9A	4kW 5A	20A	1NO or 1NC	GMD-16MP

Coil voltage, DC

- ① Standard type : 12, 20, 24, 36, 42, 48, 60, 72, 110, 120, 125, 220, 240, 250V DC
- ② Low consumption type : 12, 20, 24, 48, 72, 110, 120V DC(Low)
- ③ Wide Voltage : 12, 20, 24, 48, 72, 110, 12V DC(Wide)

Ordering information

Type, Auxiliary contact and Coil voltage

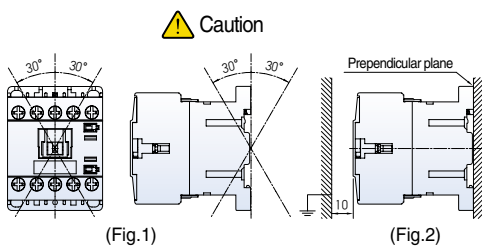

*Even installing direction takes the direction of Fig.1 to perpendicular, ip to the direction of the 30°.
Keep the distance more than 10mm with arc space shown Fig.2

Certificate
CE, ULcUL

Starters

- Open types
- Direct (Full voltage) types
- Coil voltage : AC
- Contactors : screw clamp connection types
- Overload relays : differential or non-differential types

AC coil contactor + Differential type overload relay



Devices combined		AC3 ratings (IEC60947-4)				Auxiliary contacts	Starter Type
Contactor (AC coil)	Overload (differential)	220 ~ 240V	380 ~ 440V	500 ~ 550V	690V		
GMC-6M	GTK-12M	1.5kW 7A	2.2kW 6A	3kW 5A	3kW 4A	1NO or 1NC	GMS-6M/K
GMC-9M	GTK-12M	2.2kW 9A	4kW 9A	3.7kW 6A	4kW 5A	1NO or 1NC	GMS-9M/K
GMC-12M	GTK-12M	3kW 12A	5.5kW 12A	4kW 7A	4kW 5A	1NO or 1NC	GMS-12M/K
GMC-16M	GTK-12M	4kW 15A	7.5kW 16A	5.5kW 9A	4kW 5A	1NO or 1NC	GMS-16M/K

AC coil contactor + Non-differential type overload relay

Devices combined		AC3 ratings (IEC60947-4)				Auxiliary contacts	Starter Type
Contactor (AC coil)	Overload (differential)	220 ~ 240V	380 ~ 440V	500 ~ 550V	690V		
GMC-6M	GTH-12M/3	1.5kW 7A	2.2kW 6A	3kW 5A	3kW 4A	1NO or 1NC	GMS-6M
GMC-9M	GTH-12M/3	2.2kW 9A	4kW 9A	3.7kW 6A	4kW 5A	1NO or 1NC	GMS-9M
GMC-12M	GTH-12M/3	3kW 12A	5.5kW 12A	4kW 7A	4kW 5A	1NO or 1NC	GMS-12M
GMC-16M	GTH-12M/3	4kW 15A	7.5kW 16A	5.5kW 9A	4kW 5A	1NO or 1NC	GMS-16M

Coil voltage, AC 50/60Hz

24, 36, 42, 48, 110, 115, 120, 127, 200 / 208, 220, 220 / 230, 230 / 240, 256, 277, 380 / 400, 400, 440, 480, 500, 550V AC

Ordering information

Type, Auxiliary contact and Coil voltage
Overload relay setting range

Certificate
CE, ULcUL

Reversing contactors

- For motor control
- Mechanically interlocked
- Coil voltage : AC

Screw clamp connection types



Frame size	AC3 ratings (IEC60947-4)				AC1 rating lth	Auxiliary contact (standard)	Type
	220 ~ 240V	380 ~ 440V	500 ~ 550V	690V			
6A	1.5kW	2.2kW	3kW	3kW	20A	1NO or 1NC	GMC-6MR
	7A	6A	5A	4A			
9A	2.2kW	4kW	3.7kW	4kW	20A	1NO or 1NC	GMC-9MR
	9A	9A	6A	5A			
12A	3kW	5.5kW	4kW	4kW	20A	1NO or 1NC	GMC-12MR
	12A	12A	7A	5A			
16A	4kW	7.5kW	5.5kW	4kW	20A	1NO or 1NC	GMC-16MR
	15A	16A	9A	5A			

Fast-on connection types



Frame size	AC3 ratings (IEC60947-4)				AC1 rating lth	Auxiliary contact (standard)	Type
	220 ~ 240V	380 ~ 440V	500 ~ 550V	690V			
6A	1.5kW	2.2kW	3kW	3kW	20A	1NO or 1NC	GMC-6MFR
	7A	6A	5A	4A			
9A	2.2kW	4kW	3.7kW	4kW	20A	1NO or 1NC	GMC-9MFR
	9A	9A	6A	5A			
12A	3kW	5.5kW	4kW	4kW	20A	1NO or 1NC	GMC-12MFR
	12A	12A	7A	5A			
16A	4kW	7.5kW	5.5kW	4kW	20A	1NO or 1NC	GMC-16MFR
	15A	16A	9A	5A			

Coil voltage, AC 50/60Hz

24, 36, 42, 48, 110, 115, 120, 127, 200 / 208, 220, 220 / 230, 230 / 240, 256, 277, 380 / 400, 400, 440, 480, 500, 550V AC

Certificate
CE, ULcUL

Ordering information

Type, Auxiliary contact and Coil voltage

Reversing contactors

- For motor control
- Mechanically interlocked
- Coil voltage : AC

Cage clamp connection types



Frame size	AC3 ratings (IEC60947-4)				AC1 rating Ith	Auxiliary contact (standard)	Type
	220 ~ 240V	380 ~ 440V	500 ~ 550V	690V			
6A	1.5kW 7A	2.2kW 6A	3kW 5A	3kW 4A	20A	1NO or 1NC	GMC-6MCR
9A	2.2kW 9A	4kW 9A	3.7kW 6A	4kW 5A	20A	1NO or 1NC	GMC-9MCR
12A	3kW 12A	5.5kW 12A	4kW 7A	4kW 5A	20A	1NO or 1NC	GMC-12MCR
16A	4kW 15A	7.5kW 16A	5.5kW 9A	4kW 5A	20A	1NO or 1NC	GMC-16MCR

Solder pin connection types



Frame size	AC3 ratings (IEC60947-4)				AC1 rating Ith	Auxiliary contact (standard)	Type
	220 ~ 240V	380 ~ 440V	500 ~ 550V	690V			
6A	1.5kW 7A	2.2kW 6A	3kW 5A	3kW 4A	20A	1NO or 1NC	GMC-6MPR
9A	2.2kW 9A	4kW 9A	3.7kW 6A	4kW 5A	20A	1NO or 1NC	GMC-9MPR
12A	3kW 12A	5.5kW 12A	4kW 7A	4kW 5A	20A	1NO or 1NC	GMC-12MPR
16A	4kW 15A	7.5kW 16A	5.5kW 9A	4kW 5A	20A	1NO or 1NC	GMC-16MPR

Coil voltage, AC 50/60Hz

24, 36, 42, 48, 110, 115, 120, 127, 200 / 208, 220, 220 / 230, 230 / 240, 256, 277, 380 / 400
400, 440, 480, 500, 550V AC

Certificate
CE, ULcUL

Ordering information

Type, Auxiliary contact and Coil voltage

Reversing contactors

- For motor control
- Mechanically interlocked
- Coil voltage : DC

Screw clamp connection types



Frame size	AC3 ratings (IEC60947-4)				AC1 rating lth	Auxiliary contact (standard)	Type
	220 ~ 240V	380 ~ 440V	500 ~ 550V	690V			
6A	1.5kW 7A	2.2kW 6A	3kW 5A	3kW 4A	20A	1NO or 1NC	GMD-6MR
9A	2.2kW 9A	4kW 9A	3.7kW 6A	4kW 5A	20A	1NO or 1NC	GMD-9MR
12A	3kW 12A	5.5kW 12A	4kW 7A	4kW 5A	20A	1NO or 1NC	GMD-12MR
16A	4kW 15A	7.5kW 16A	5.5kW 9A	4kW 5A	20A	1NO or 1NC	GMD-16MR

Fast-on connection types



Frame size	AC3 ratings (IEC60947-4)				AC1 rating lth	Auxiliary contact (standard)	Type
	220 ~ 240V	380 ~ 440V	500 ~ 550V	690V			
6A	1.5kW 7A	2.2kW 6A	3kW 5A	3kW 4A	20A	1NO or 1NC	GMD-6MFR
9A	2.2kW 9A	4kW 9A	3.7kW 6A	4kW 5A	20A	1NO or 1NC	GMD-9MFR
12A	3kW 12A	5.5kW 12A	4kW 7A	4kW 5A	20A	1NO or 1NC	GMD-12MFR
16A	4kW 15A	7.5kW 16A	5.5kW 9A	4kW 5A	20A	1NO or 1NC	GMD-16MFR

Coil voltage, DC

- ① Standard type : 12, 20, 24, 36, 42, 48, 60, 72, 110, 120, 125, 220, 240, 250V DC
- ② Low consumption type : 12, 20, 24, 48, 72, 110, 120V DC(Low)
- ③ Wide Voltage : 12, 20, 24, 48, 72, 110, 12V DC(Wide)

Ordering information

Type, Auxiliary contact and Coil voltage

Certificate
CE, ULcUL

Reversing contactors

- For motor control
- Mechanically interlocked
- Coil voltage : DC

Cage clamp connection types



Frame size	AC3 ratings (IEC60947-4)				AC1 rating Ith	Auxiliary contact (standard)	Type
	220 ~ 240V	380 ~ 440V	500 ~ 550V	690V			
6A	1.5kW 7A	2.2kW 6A	3kW 5A	3kW 4A	20A	1NO or 1NC	GMD-6MCR
9A	2.2kW 9A	4kW 9A	3.7kW 6A	4kW 5A	20A	1NO or 1NC	GMD-9MCR
12A	3kW 12A	5.5kW 12A	4kW 7A	4kW 5A	20A	1NO or 1NC	GMD-12MCR
16A	4kW 15A	7.5kW 16A	5.5kW 9A	4kW 5A	20A	1NO or 1NC	GMD-16MCR

Solder pin connection types



Frame size	AC3 ratings (IEC60947-4)				AC1 rating Ith	Auxiliary contact (standard)	Type
	220 ~ 240V	380 ~ 440V	500 ~ 550V	690V			
6A	1.5kW 7A	2.2kW 6A	3kW 5A	3kW 4A	20A	1NO or 1NC	GMD-6MSR
9A	2.2kW 9A	4kW 9A	3.7kW 6A	4kW 5A	20A	1NO or 1NC	GMD-9MSR
12A	3kW 12A	5.5kW 12A	4kW 7A	4kW 5A	20A	1NO or 1NC	GMD-12MSR
16A	4kW 15A	7.5kW 16A	5.5kW 9A	4kW 5A	20A	1NO or 1NC	GMD-16MSR

Coil voltage, DC

- ① Standard type : 12, 20, 24, 36, 42, 48, 60, 72, 110, 120, 125, 220, 240, 250V DC
- ② Low consumption type : 12, 20, 24, 48, 72, 110, 120V DC(Low)
- ③ Wide Voltage : 12, 20, 24, 48, 72, 110, 12V DC(Wide)

Ordering information

Type, Auxiliary contact and Coil voltage

Certificate
CE, ULcUL

Bimetallic style Overload Relays

Description



GT-12M

- Direct mount on the mini contactors with screw clamp connection.
contactor types : GMC(D)-6M, GMC(D)-9M, GMC(D)-12M, GMC(D)-16M,
- DIN rail or screw mountable with the optional base AZ-22H
- Small physical size : 44 mm wide
- 1NO+1NC trip contacts
- Trip class 10A according to IEC60947-4-1
- Differential current/Phase failure protection : GTK types
- Non-differential GTH types are available for the economic solution
- Ambient compensated -5 to 40 °C
- Manual/Automatic reset convertible.
- Remote reset is optional
- Trip free designed

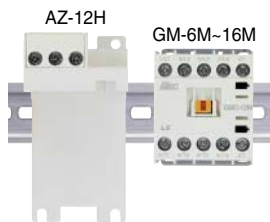

Separate mount

Direct mount



GT-12M

Catalog No.

Setting ranges(A)	Differential type	Non-differential type	
	3-heater	3-heater	2-heater
	0.1 - 0.16	GTK-12M • 0.14	GTH-12M/3 • 0.14
0.16 - 0.25	GTK-12M • 0.21	GTH-12M/3 • 0.21	GTH-12M • 0.21
0.25 - 0.4	GTK-12M • 0.33	GTH-12M/3 • 0.33	GTH-12M • 0.33
0.4 - 0.63	GTK-12M • 0.52	GTH-12M/3 • 0.52	GTH-12M • 0.52
0.63 - 1	GTK-12M • 0.82	GTH-12M/3 • 0.82	GTH-12M • 0.82
1 - 1.6	GTK-12M • 1.3	GTH-12M/3 • 1.3	GTH-12M • 1.3
1.6 - 2.5	GTK-12M • 2.1	GTH-12M/3 • 2.1	GTH-12M • 2.1
2.5 - 4	GTK-12M • 3.3	GTH-12M/3 • 3.3	GTH-12M • 3.3
4 - 6	GTK-12M • 5	GTH-12M/3 • 5	GTH-12M • 5
5 - 8	GTK-12M • 6.5	GTH-12M/3 • 6.5	GTH-12M • 6.5
6 - 9	GTK-12M • 7.5	GTH-12M/3 • 7.5	GTH-12M • 7.5
7 - 10	GTK-12M • 8.5	GTH-12M/3 • 8.5	GTH-12M • 8.5
9 - 13	GTK-12M • 12	GTH-12M/3 • 12	GTH-12M • 12
12 - 16	GTK-12M • 14	GTH-12M/3 • 14	GTH-12M • 14

Auxiliary (Trip) contact rating

	AC15(11) duty			DC13(11) duty	
	110V	220V	550V	110V	220V
	2.5(0.3)A	2(0.3)A	1(0.3)A	0.28A	0.14A

Note) Values of () are the ratings of NO contact under auto reset mode.

Certificate
CE, ULcUL

Bimetallic style Overload Relays

Configuration of the front face

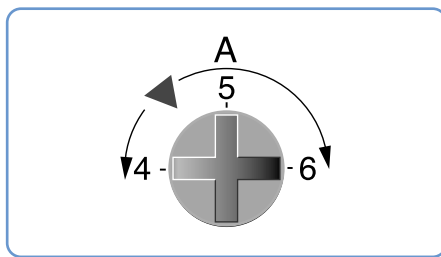
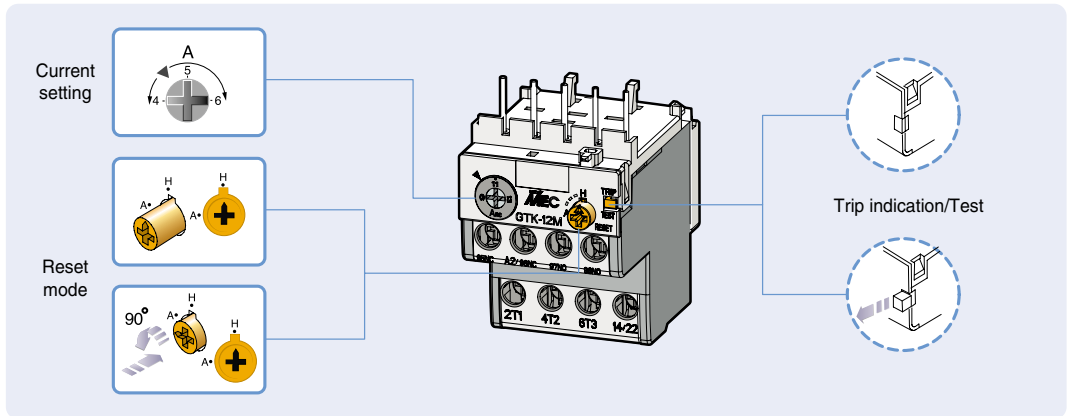

3-step current setting

To set the current turn the setting dial using a crosshead screw driver.



Trip indicator

If the TOR is tripped, it protrudes by 2 to 3mm to indicate the state. It can be used as a test trip button by pulling it manually.

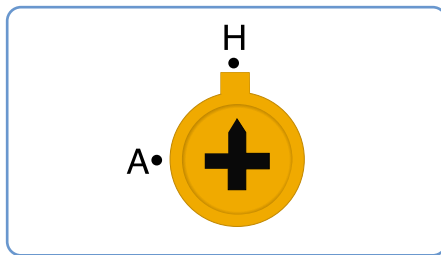

Manual / Auto reset selection

Use a crosshead screw driver to switch the reset mode.

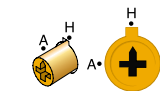

Manual mode, H

Turn the reset dial into the "H" position and it will protrude.



Automatic mode, A

Press the reset dial and turn it counterclockwise to lock in the position "A"

Circuit diagram

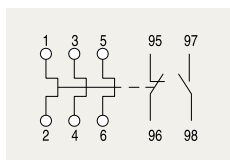

Overload Relay

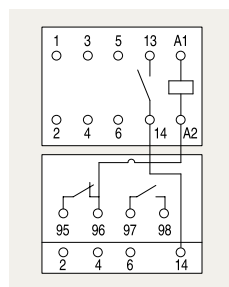

Contactor+Overload Relay

Contactors relays

Description

- 4-, 6-, 8-pole units
- Finger proof design
- 16A continuous current, Ith
- 44mm wide
- DIN rail or screw mountable
- AC/DC control voltage

Selection



Poles	Composition	Types		Remarks
		AC control	DC control	
4 pole	4NO	GMR-4M	GMR-4MD	Additional 2NO or 4NO auxiliary contact block can be mounted on these relays.
	3NO+1NC			
	2NO+2NC			
	1NO+3NC			
6 pole	4NC	GMR-6M	GMR-6MD	GMR-4M + AU-2M
	6NO			
	5NO+1NC			
	4NO+2NC			
8 pole	3NO+3NC	GMR-8M	GMR-8MD	GMR-4M + AU-4M
	2NO+4NC			
	8NO			
	7NO+1NC			
	6NO+2NC			
	5NO+3NC			
	4NO+4NC			

Contact ratings

		Rated currents		Making/Breaking currents	
		Inductive load	Resistive load	Inductive load	Resistive load
AC duty	120V	6A	10A	66A	66A
	240V	3A	8A	33A	33A
	480V	1.5A	5A	16.5A	16.5A
	600V	1.2A	5A	13.2A	13.2A
DC duty	125V	0.55A	5A	3.7A	
	250V	0.27A	3A	1.8A	
	440V	0.31A	2.5A	1.4A	
	600V	0.1A	1A	0.7A	
Continuous current, Ith		10A			

Note) Minimum voltage/current is 24V DC 10mA

Performance

Operation cycle			1800 operations/hour	
Endurance	Mechanical lifetime		20 mil. Operations	
	Electrical lifetime	AC15 duty	220V	0.5 mil. operations
			440V	0.5 mil. operations
		AC12 duty	220V	0.25 mil. operations
			440V	0.25 mil. operations
	DC13, 12 duty	24-220V	0.5 mil. operations	

Coil voltage, AC 50/60Hz

24, 36, 42, 48, 110, 115, 120, 127, 200 / 208, 220, 220 / 230, 230 / 240, 256, 277, 380 / 400, 400, 440, 480, 500, 550V AC

Coil voltage, DC

- ① Standard type : 12, 20, 24, 36, 42, 48, 60, 72, 110, 120, 125, 220, 240, 250V DC
- ② Low consumption type : 12, 20, 24, 48, 72, 110, 120V DC(Low)
- ③ Wide Voltage : 12, 20, 24, 48, 72, 110, 12V DC(Wide)

Contactor relays

Circuit diagram

GMR-4M					
GMR-6M					
GMR-8M					

- Note) 1. AU-2M auxiliary contact unit
 2. AU-4M auxiliary contact unit
 3. In case of adding the auxiliary contact unit AU-2M or AU-4M onto the Contactor relay GMR-4M or 4DM please follow the contact configuration indicated in the table.

How to add a auxiliary contact unit onto a contactor relay

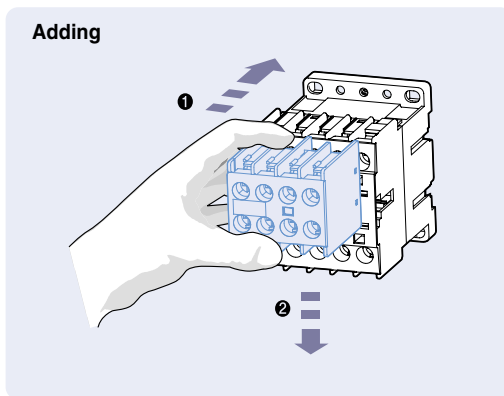

- ① Set the unit onto the relay.
- ② Push the unit down.

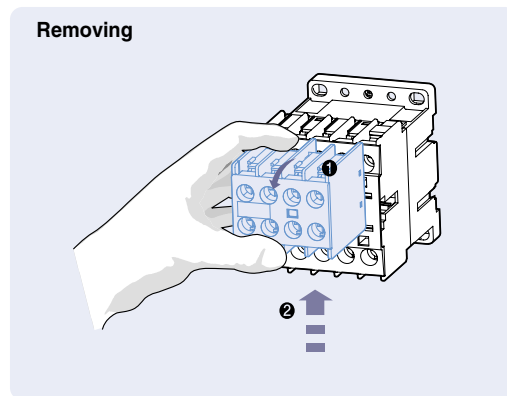

- ① Pull the end of the hook of the unit with finger.
- ② Push the unit up.

Auxiliary contact

Front mount blocks

Side mount blocks

Screw clamp connection



Fast-on connection

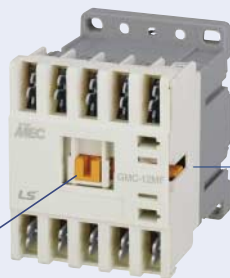

Cage clamp connection

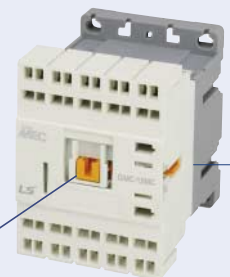

Solder pin connection



Auxiliary contact

Catalog No.

Connection type	Applying contactors	Mounting type	Composition	Catalog no.
Screw clamp	GMC-, GMD-, GMS- 6M, 6MR 9M, 9MR 12M, 12MR 16M, 16MR	Front mount	2NO	AU-2M20
			2NC	AU-2M02
			1NO+1NC	AU-2M11
			4NO	AU-4M40
			3NO+1NC	AU-4M31
			2NO+2NC	AU-4M22
			1NO+3NC	AU-4M13
			4NC	AU-4M04
		Side mount	1NO	AU-1M10
			1NC	AU-1M01
Fast-on	GMC-, GMD-, GMS- 6MF, 6MRF 9MF, 9MRF 12MF, 12MRF 16MF, 16MRF	Front mount	2NO	AU-2MF20
			2NC	AU-2MF02
			1NO+1NC	AU-2MF11
			4NO	AU-4MF40
			3NO+1NC	AU-4MF31
			2NO+2NC	AU-4MF22
			1NO+3NC	AU-4MF13
			4NC	AU-4MF04
		Side mount	1NO	AU-1MF10
			1NC	AU-1MF01
Cage clamp	GMC-, GMD-, GMS- 6MC, 6MRC 9MC, 9MRC 12MC, 12MRC 16MC, 16MRC	Front mount	2NO	AU-2MC20
			2NC	AU-2MC02
			1NO+1NC	AU-2MC11
			4NO	AU-4MC40
			3NO+1NC	AU-4MC31
			2NO+2NC	AU-4MC22
			1NO+3NC	AU-4MC13
			4NC	AU-4MC04
		Side mount	1NO	AU-1MC10
			1NC	AU-1MC01
Solder pin	GMC-, GMD-, GMS- 6MP, 6MRP 9MP, 9MRP 12MP, 12MRP 16MP, 16MRP	Side mount	1NO	AU-1MP10
			1NC	AU-1MP01

Timer unit, AT-12M

- Electronic type
- ON/OFF time delay
- Front mount

Timer unit

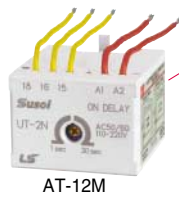

AT-12M



Surge absorber unit



AS-12M

Electronic Timer

Type	Control voltage	Delay	Time	Applied contactors
AT-12M / IN	AC/DC 24~48V	ON	0.1~30s	GMC-6M~16M GMD-6M~16M
AT-12M / IF	AC/DC 24~48V	OFF	0.1~30s	GMC-6M~16M GMD-6M~16M
AT-12M / 2N	AC 100~220V	ON	0.1~30s	GMC-6M~16M GMD-6M~16M
AT-12M / 2F	AC 100~220V	OFF	0.1~30s	GMC-6M~16M GMD-6M~16M

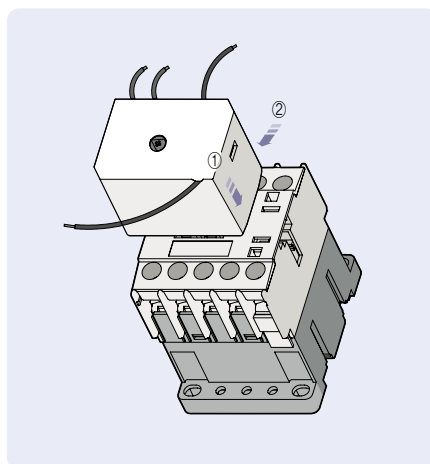

Set the unit ① onto the contactor and assemble it by sliding in the direction of ② .

To remove the unit from the contactor do it in reverse order.

ON-delay Timer

Used to delay the closing of the contactor between 1 to 30s.

Operation sequence

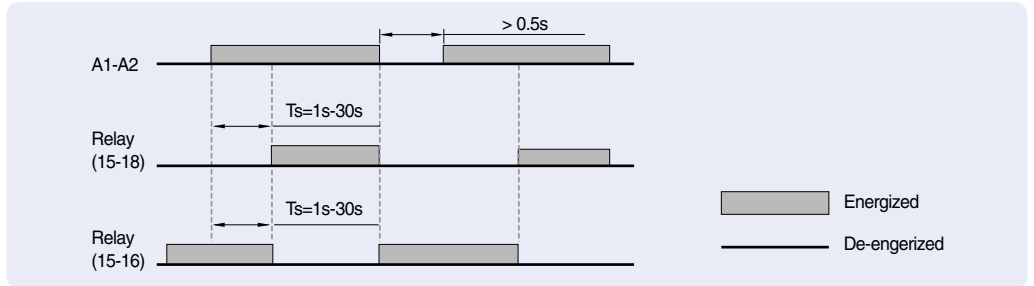

18 15 A1
MEC ON DELAY
 AT-12M AC/DC 24-48V
 LS 1sec 30sec A2

Setting a time as $T_s=1s$

18 15 A1
MEC ON DELAY
 AT-12M AC/DC 24-48V
 LS 1sec 30sec A2

Setting a time as $T_s=30s$

Circuit diagram

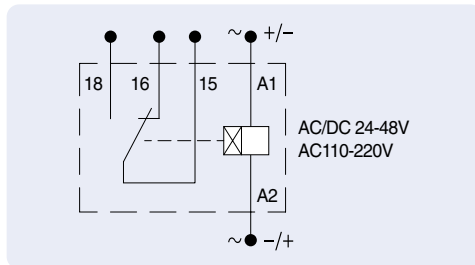

Application

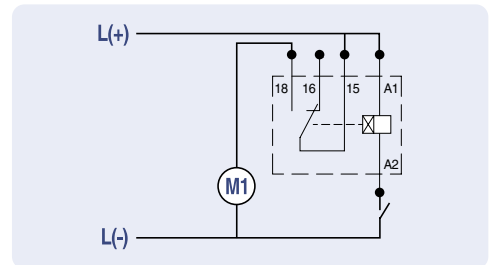

OFF-delay Timer

Circuit

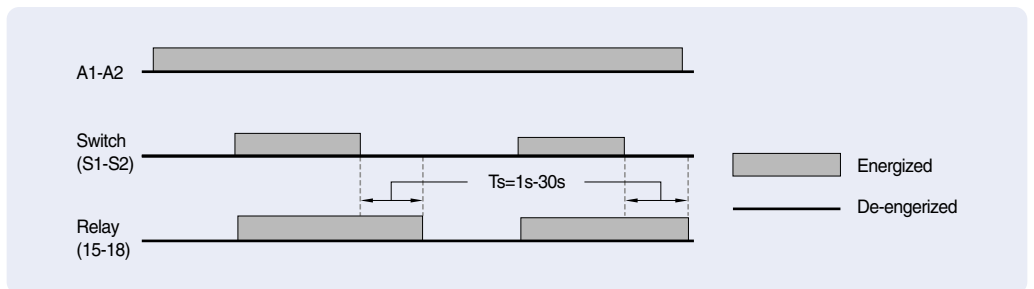

18 15 S1 S2 A1
MEC OFF DELAY
 AT-12M AC/DC 24-48V
 LS 1sec 30sec A2

Setting a time as $T_s=1s$

18 15 S1 S2 A1
MEC OFF DELAY
 AT-12M AC/DC 24-48V
 LS 1sec 30sec A2

Setting a time as $T_s=30s$

Circuit diagram

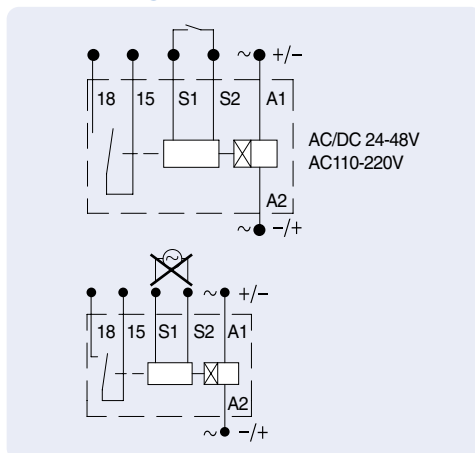

Application

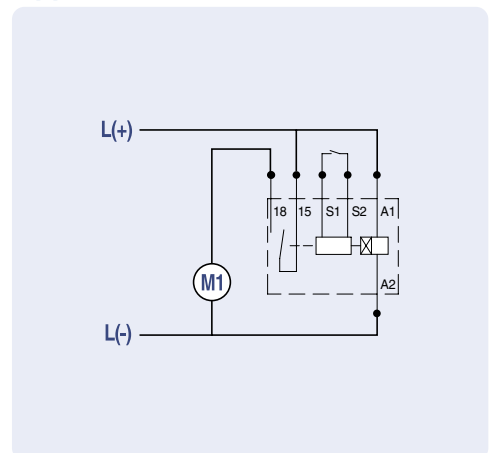

Note) 1. Do not apply power to terminals S1 and S2.
 2. To extend S1 and S2 wires, use shield cable.

Surge absorber unit, AS-12M

- Coil surge suppressor

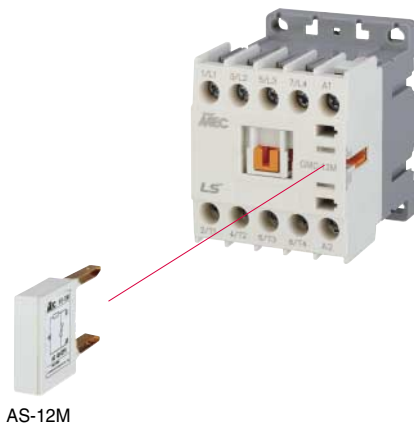

AS-12M

Surge absorber unit



Type	Internal element	Operational voltage	Applied contactors
AS-12M / 1	Varistor	AC24~48V	GMC-6M~16M
AS-12M / 2		AC60~127V	
AS-12M / 3		AC200~240V	
AS-12M / 4		DC12~24V	GMD-6M~16M
AS-12M / 5		DC30~72V	
AS-12M / 6		DC100~127V	
AS-12M / 7		DC200~250V	

Separate mounting unit, AZ-12MH

- To mount a relay separately from a contactor
- Mountable on DIN rail or by screw fixing

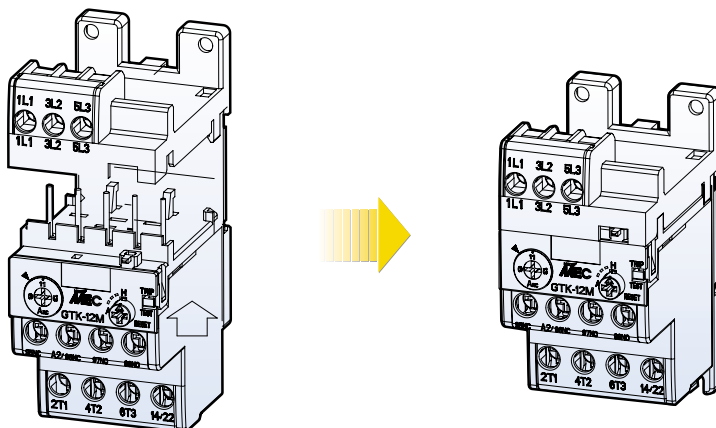

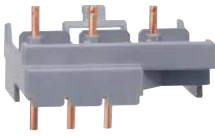

Direct adapter

Used to mount a mini contactor to a Manual motor starter directly .

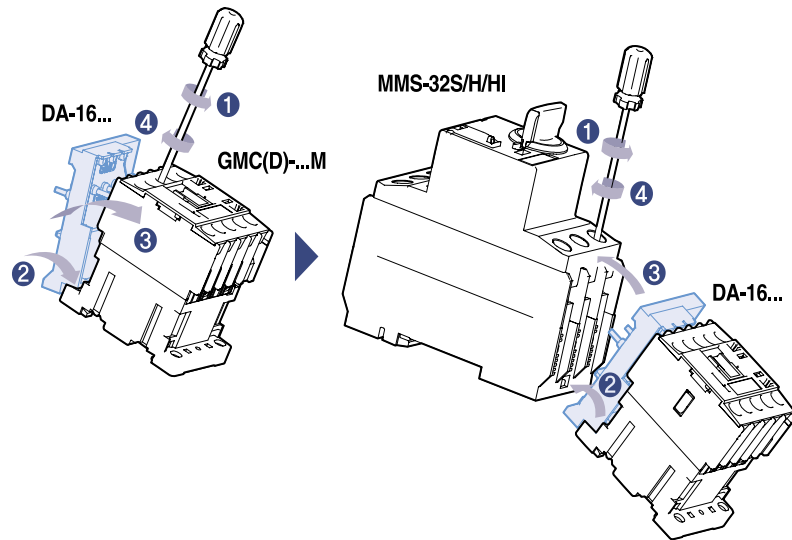

Direct adapter type

Type	Manual motor starter	+	Mini contactor
DA-16SA	MMS-32S	+	GMC-6M-16M
DA-16SD	MMS-32S	+	GMD-6M-16M
DA-16HA	MMS-32H	+	GMC-6M-16M
DA-16HD	MMS-32H	+	GMD-6M-16M



Interlock unit, AR-12M

consists of

- Mechanical interlock components
- Cable kits for line and load sides



Solder pin terminals

To modify the connection to Solder pin type from Screw clamp type
 Available for contactors and auxiliary contact blocks



DC Control

AC Control



Dimensions

Mini contactors with Screw clamp type

- GMC-6M
- GMC-9M
- GMC-12M
- GMC-16M
- GMC-6M/4
- GMC-9M/4
- GMC-12M/4
- GMC-16M/4

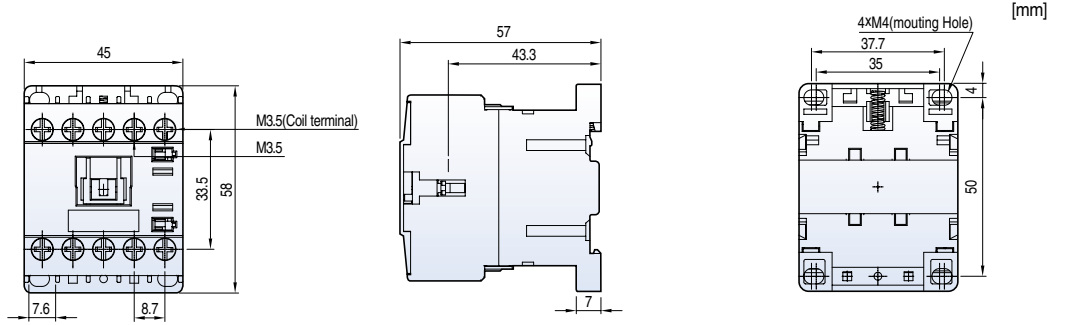

[mm]

0.17kg

- GMD-6M
- GMD-9M
- GMD-12M
- GMD-16M
- GMD-6M/4
- GMD-9M/4
- GMD-12M/4
- GMD-16M/4

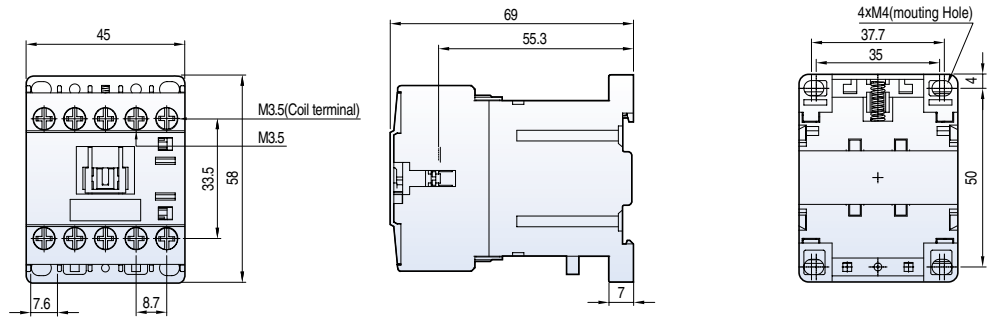

0.23kg

Circuit diagram

GMC-6M~16M, GMD-6M~16M

3-Pole contactors

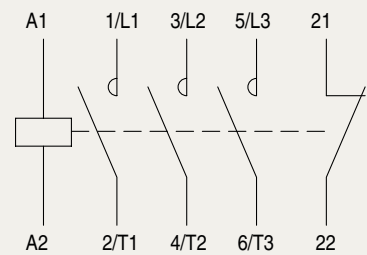
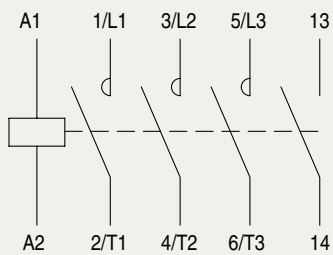

GMC-6M/4~16M/4, GMD-6M/4~16M/4

4-Pole contactors

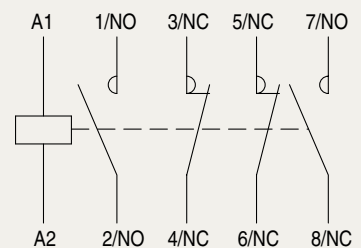
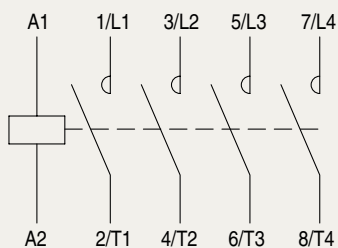

Mini contactors with Solder pin type

- GMC-6MP
- GMC-9MP
- GMC-12MP
- GMC-16MP
- GMC-6MP/4
- GMC-9MP/4
- GMC-12MP/4
- GMC-16MP/4

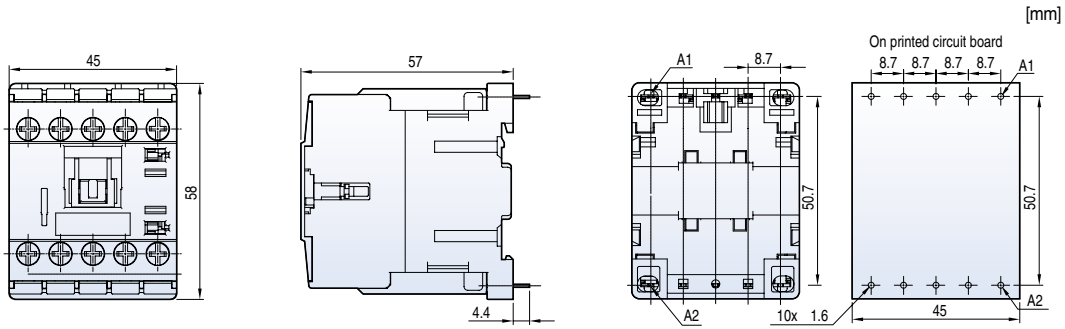

0.17kg

- GMD-6MP
- GMD-9MP
- GMD-12MP
- GMD-16MP
- GMD-6MP/4
- GMD-9MP/4
- GMD-12MP/4
- GMD-16MP/4

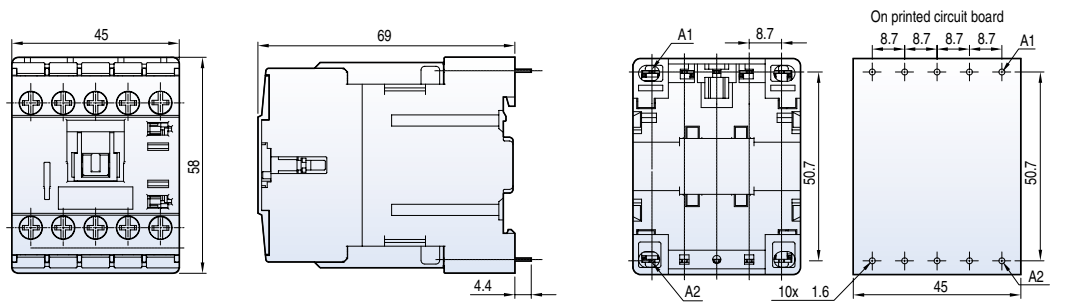

0.23kg

Circuit diagram

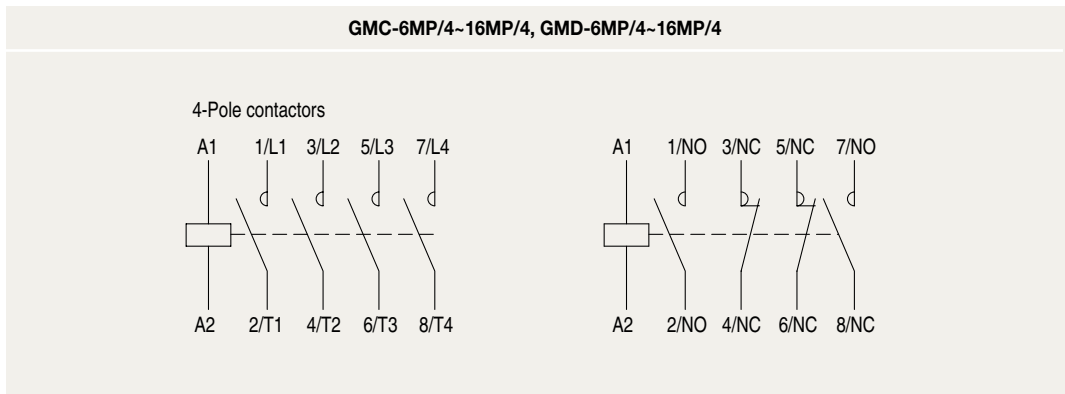
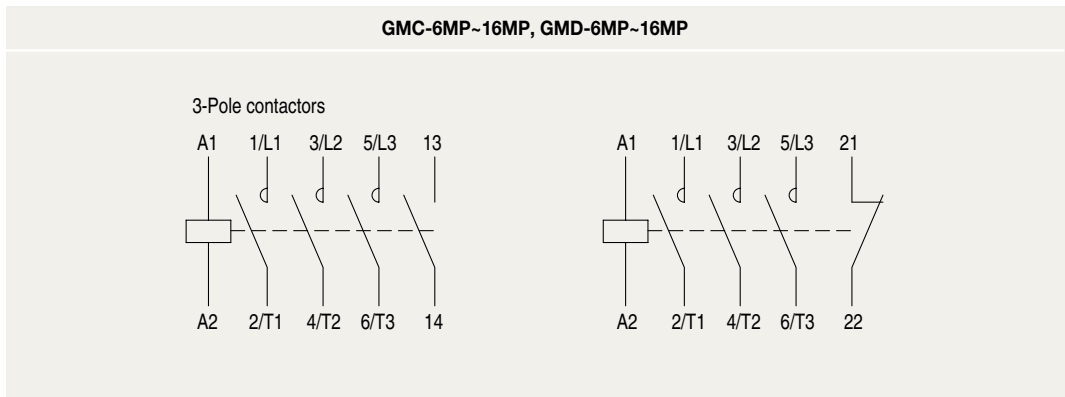

Dimensions

Mini contactors with Fast-on type

- GMC-6MF
- GMC-9MF
- GMC-12MF
- GMC-16MF
- GMC-6MF/4
- GMC-9MF/4
- GMC-12MF/4
- GMC-16MF/4

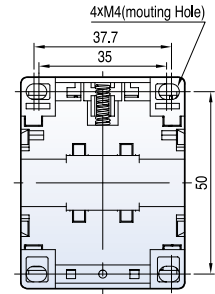
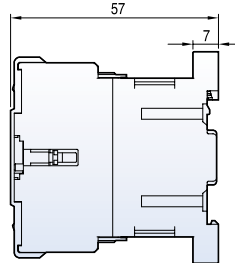
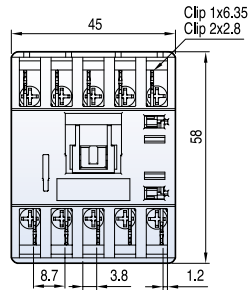

[mm]

0.18kg

- GMD-6MF
- GMD-9MF
- GMD-12MF
- GMD-16MF
- GMD-6MF/4
- GMD-9MF/4
- GMD-12MF/4
- GMD-16MF/4

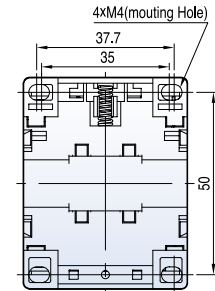
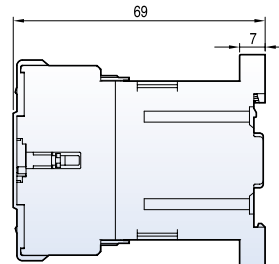
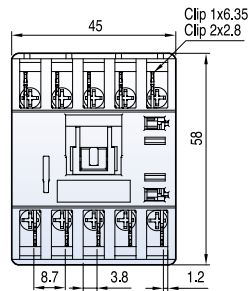

0.27kg

Circuit diagram

GMC-6MF-16MF, GMD-6MF-16MF

3-Pole contactors

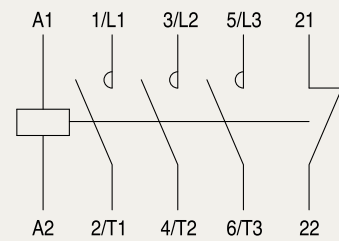
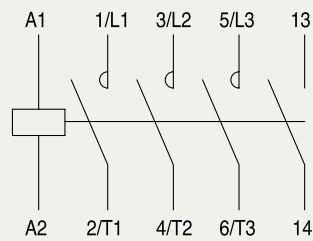

GMC-6MF/4-16MF/4, GMD-6MF/4-16MF/4

4-Pole contactors

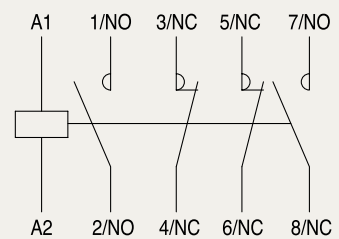
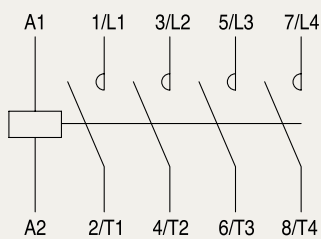

Mini contactors with Cage clamp type

- GMC-6MC
- GMC-9MC
- GMC-12MC
- GMC-16MC
- GMC-6MC/4
- GMC-9MC/4
- GMC-12MC/4
- GMC-16MC/4

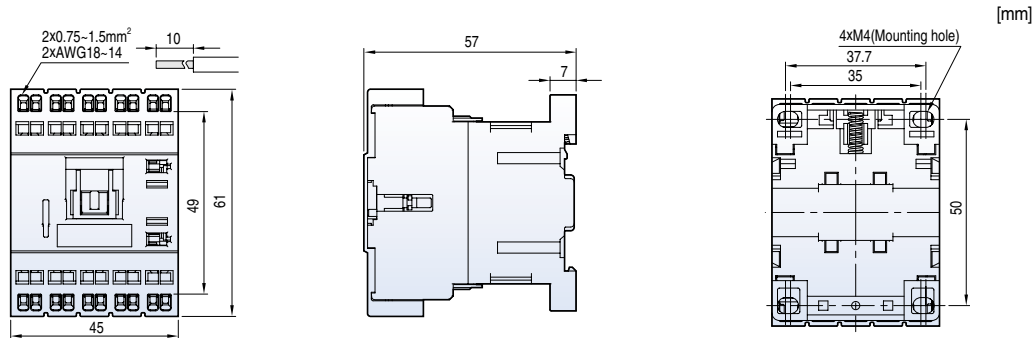

0.19kg

- GMD-6MC
- GMD-9MC
- GMD-12MC
- GMD-16MC
- GMD-6MC/4
- GMD-9MC/4
- GMD-12MC/4
- GMD-16MC/4

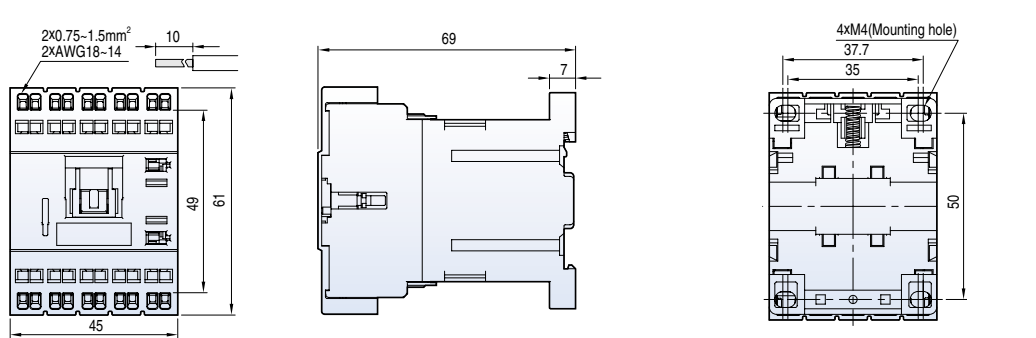

0.28kg

Circuit diagram

GMC-6MC~16MC, GMD-6MC~16MC

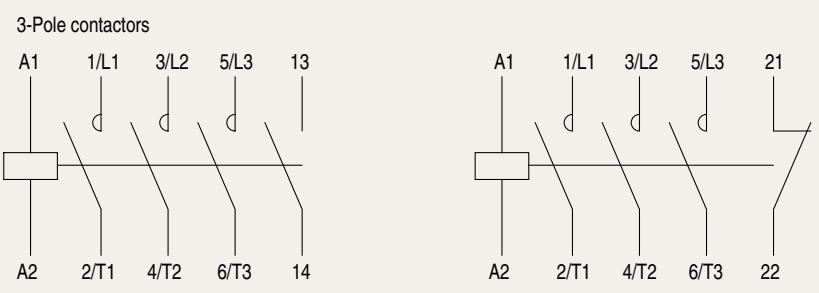

GMC-6MC/4~16MC/4, GMD-6MC/4~16MC/4

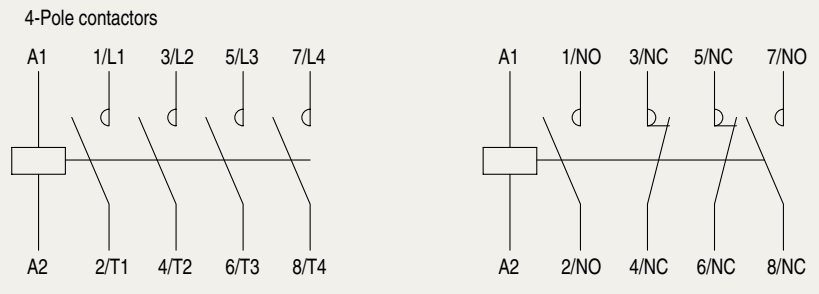

Dimensions

Mini contactors with Auxiliary contacts

- GMC-6M
- GMC-9M
- GMC-12M
- GMC-16M
- +
- AU-4M

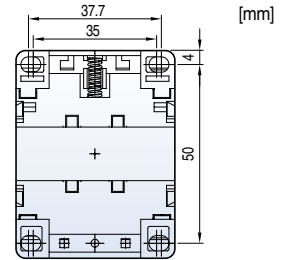
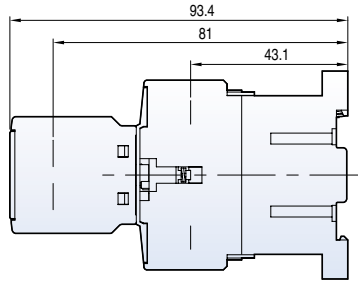
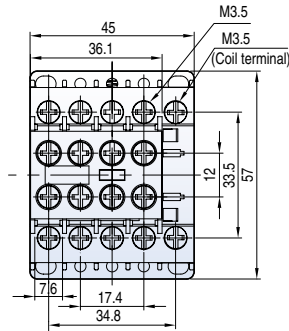

[mm]

0.21kg

- GMC-6M
- GMC-9M
- GMC-12M
- GMC-16M
- +
- 2 × AU-1M

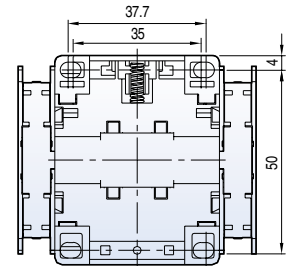
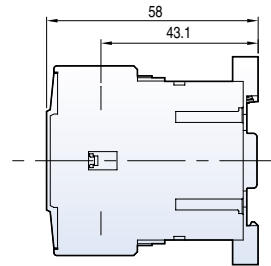
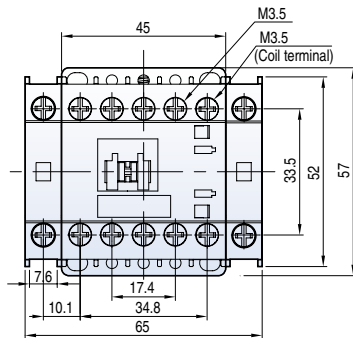

0.21kg

- GMC-6MP
- GMC-9MP
- GMC-12MP
- GMC-16MP
- +
- 2 × AU-1MP

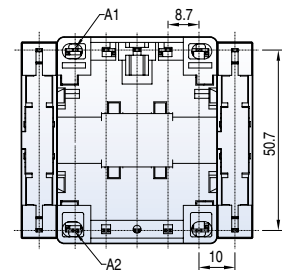
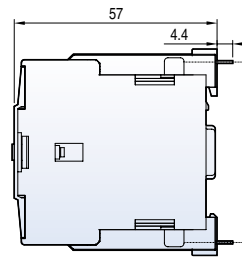
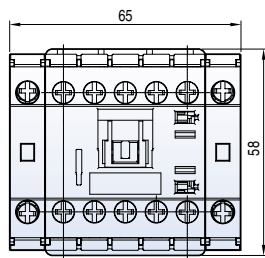

- GMC-6MF
- GMC-9MF
- GMC-12MF
- GMC-16MF
- +
- AU-4MF

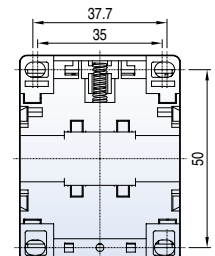
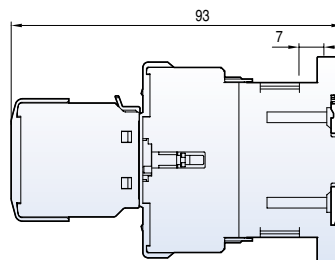
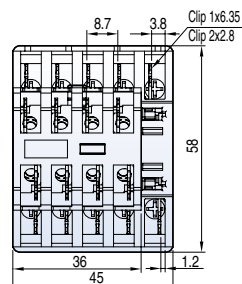

0.23kg

Mini contactors with Auxiliary contacts

- GMC-6MF
- GMC-9MF
- 2 × GMC-12MF
- GMC-16MF
- +
- AU-1MF

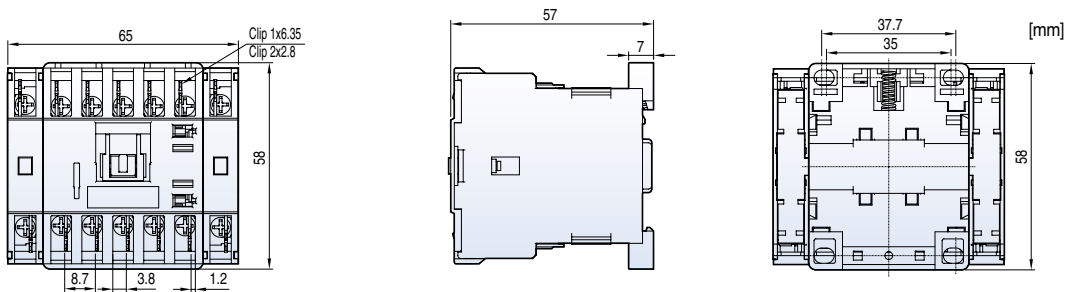

0.32kg

- GMC-6MC
- GMC-9MC
- GMC-12MC
- GMC-16MC
- +
- AU-4MC

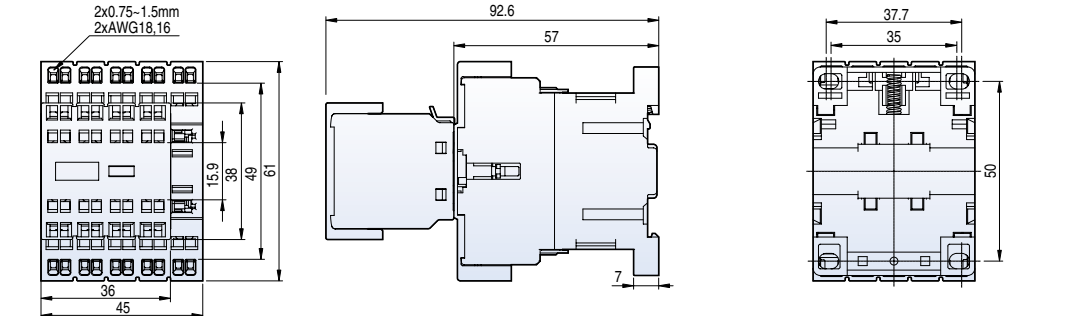

0.24kg

- GMC-6MC
- GMC-9MC
- 2 × GMC-12MC
- GMC-16MC
- +
- AU-1MC

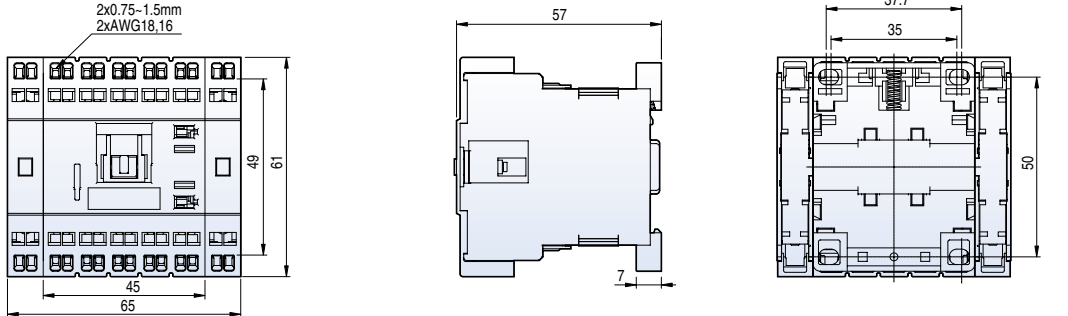

0.23kg

Dimensions

Mini contactors with external accessories

- GMC-6M
- GMC-9M
- GMC-12M
- GMC-16M
- +
- AT-12M

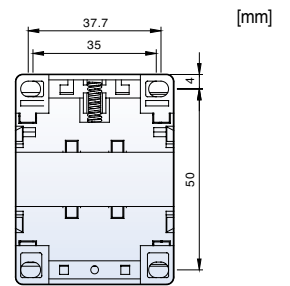
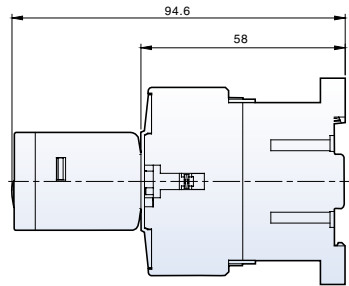
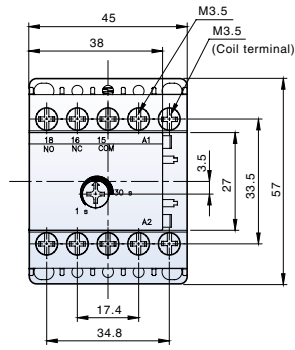

[mm]

0.21kg

- GMD-6M
- GMD-9M
- GMD-12M
- GMD-16M
- +
- AS-12M

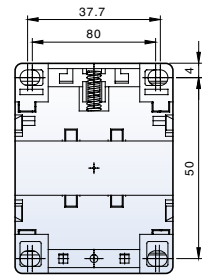
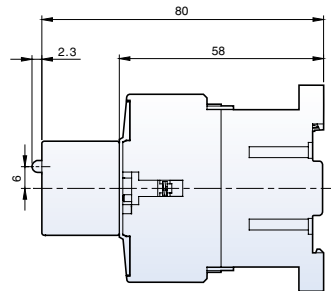
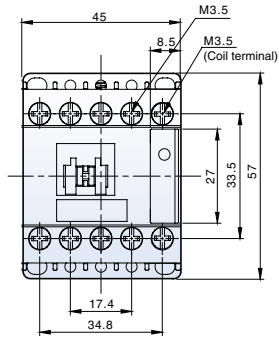

0.175kg

Thermal overload relays for Mini contactors

GTH(K)-12M

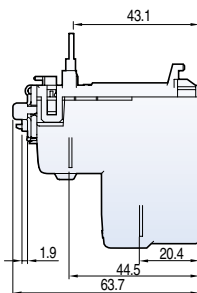
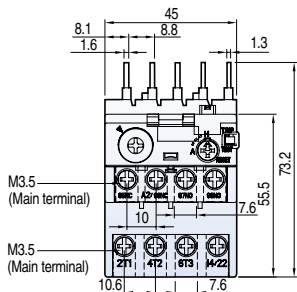

[mm]

0.1kg

GTH(K)-12MH

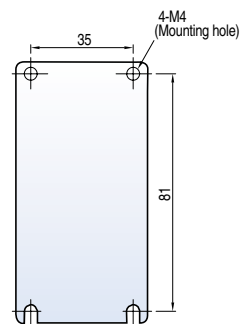
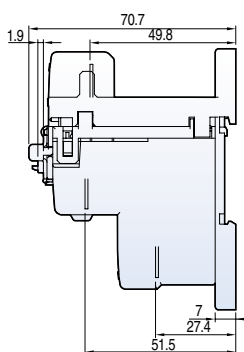
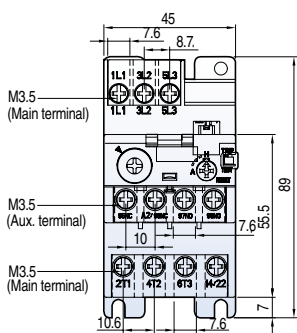

0.4kg

Dimensions

Mini motor starters, open

- GMS-6M
- GMS-9M
- GMS-12M
- GMS-16M

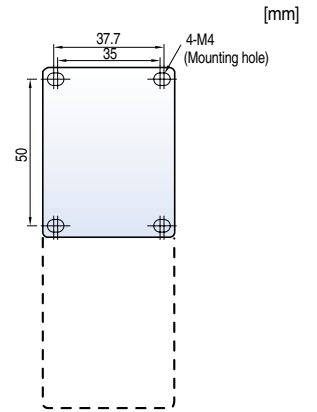
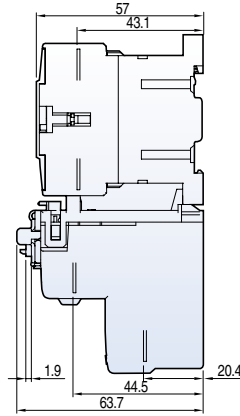
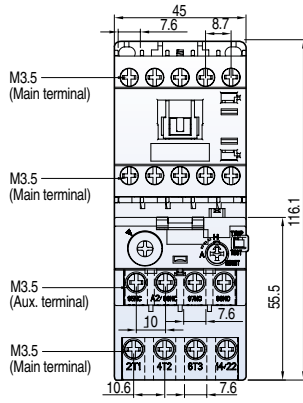

[mm]

0.26kg

- GMS-6MD
- GMS-9MD
- GMS-12MD
- GMS-16MD

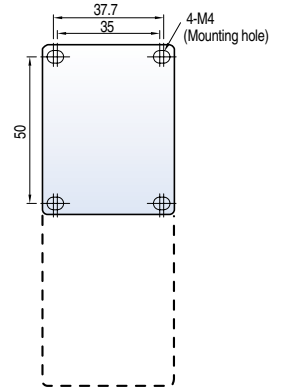
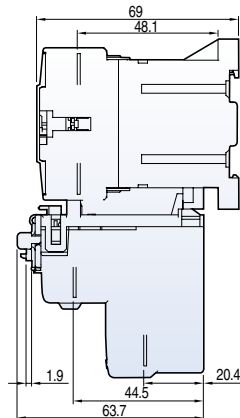
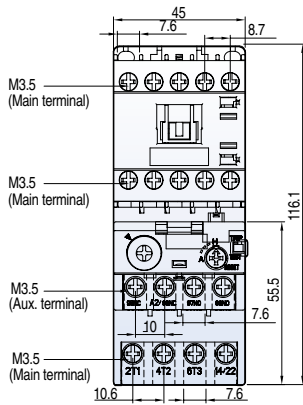

0.39kg

Mini contactor relays

[mm]

GMR-4M

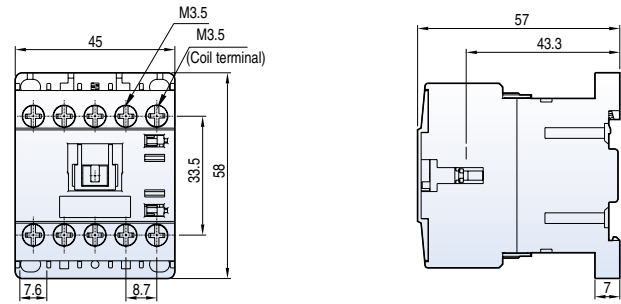

0.17kg

GMR-4MD

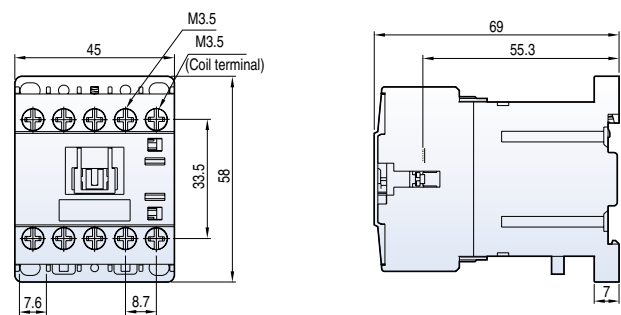

0.23kg

GMR-4M

GMR-8M

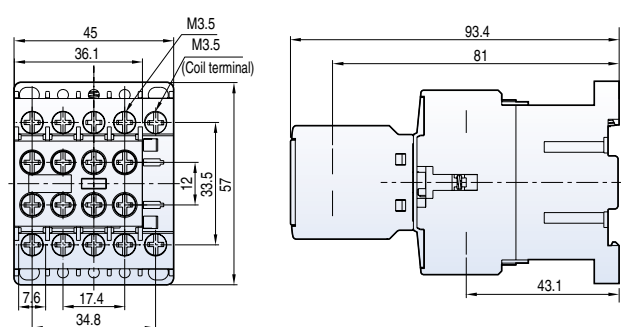

0.21kg

GMR-4M

GMR-8M

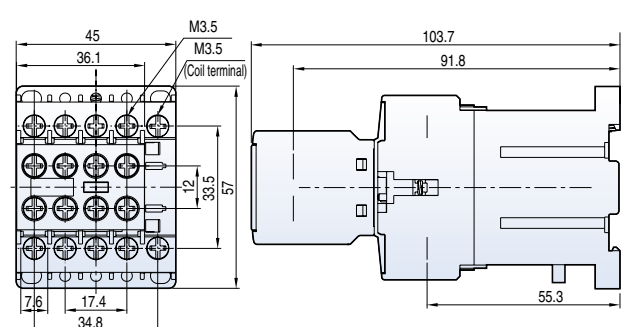

0.21kg

GMR-4M

2 × AU-1M

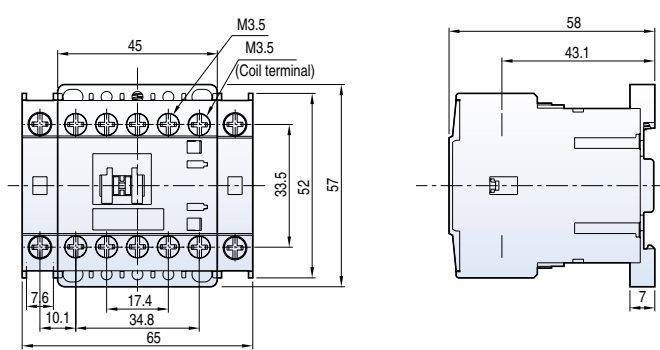

0.21kg

Dimensions

Mini contactor relays

GMR-4MP

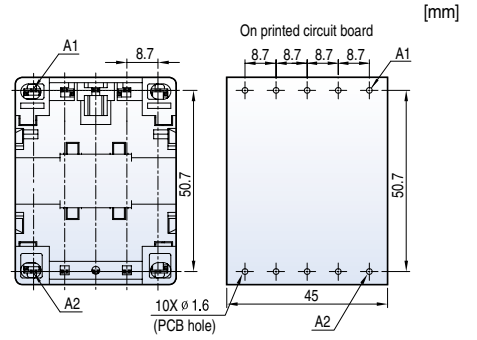
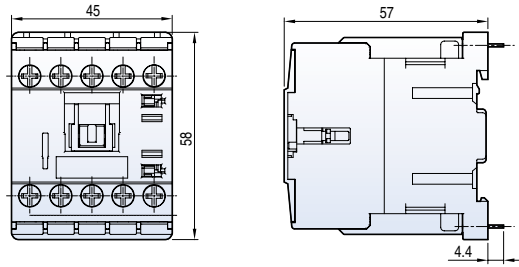

0.19kg

GMR-4MPD

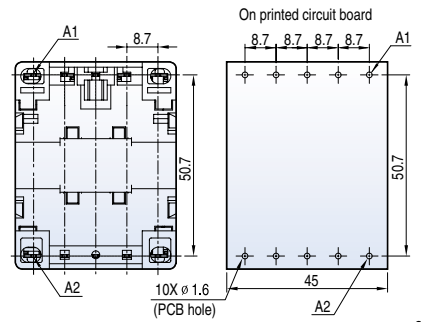
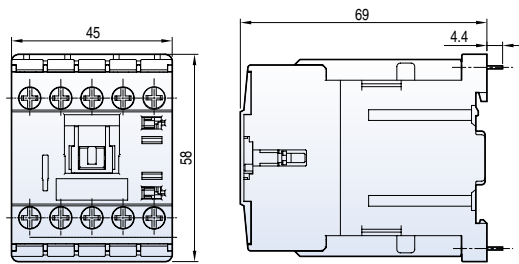

0.28kg

GMR-4MP

2x + AU-1M

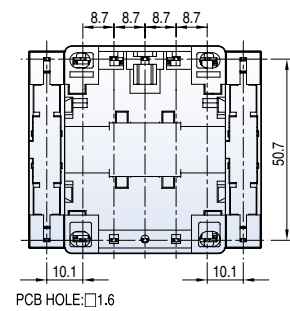
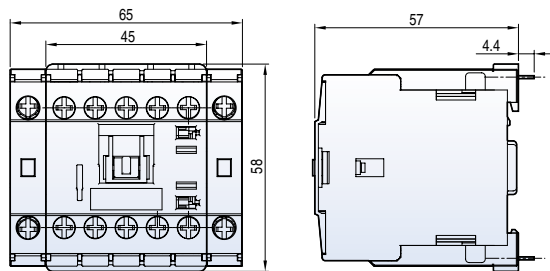

Mini contactor relays

[mm]

GMR-4MF

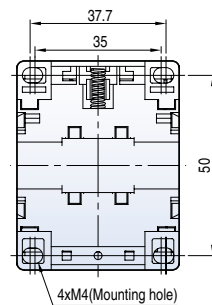
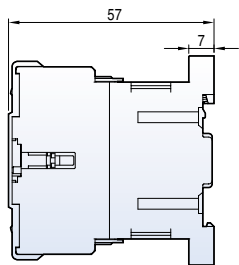
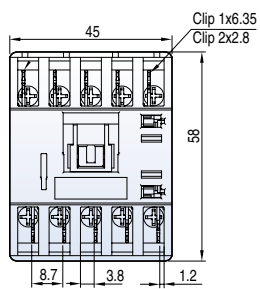

0.18kg

GMR-4MFD

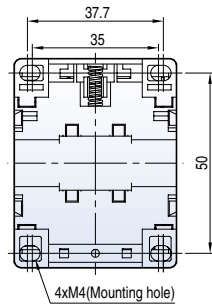
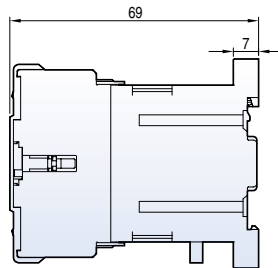
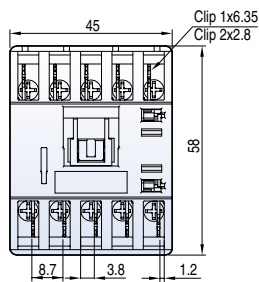

0.27kg

GMR-6MF

GMR-8MF

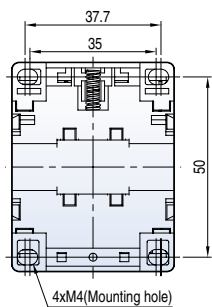
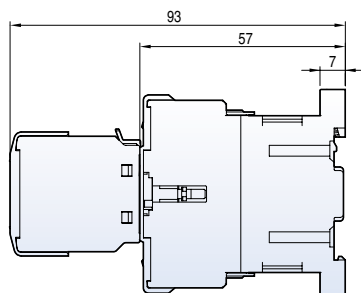
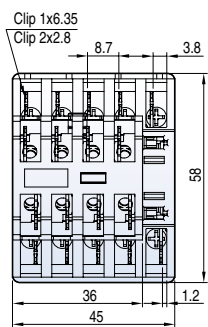

0.23kg

GMR-4MF

2 × + AU-1MF

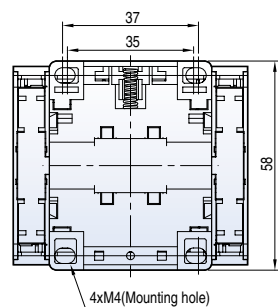
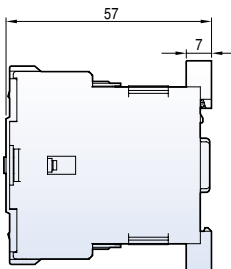
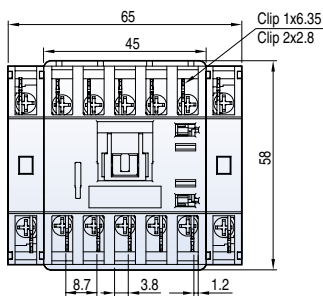

0.32kg

Dimensions

GMR-4MC

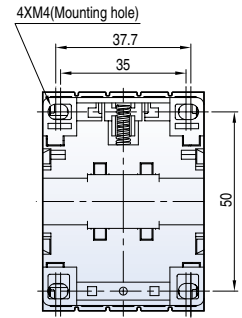
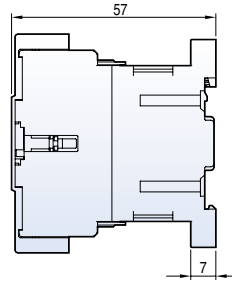
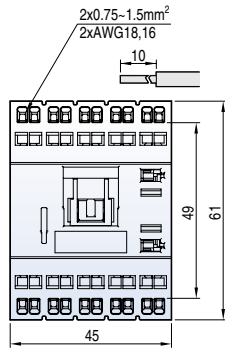

[mm]

0.18kg

GMR-4MCD

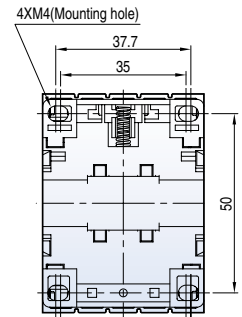
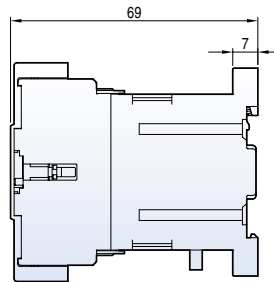
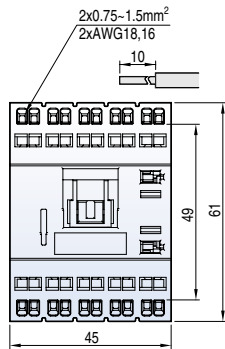

0.27kg

GMR-6MC

GMR-8MC

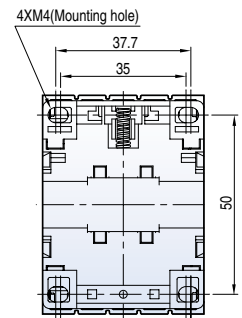
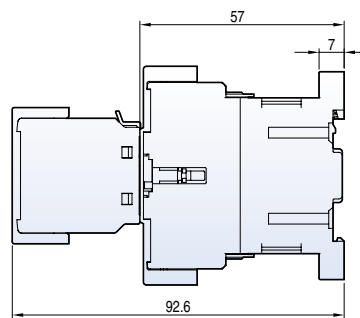
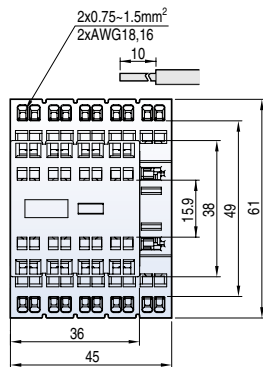

0.23kg

2 ×

GMR-4MC

+

AU-1MC

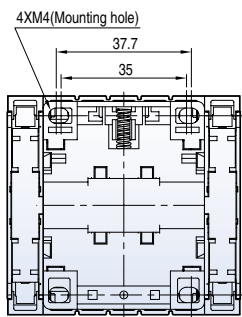
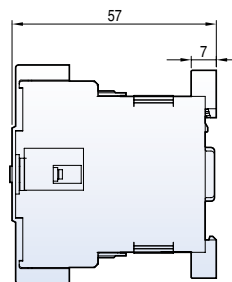
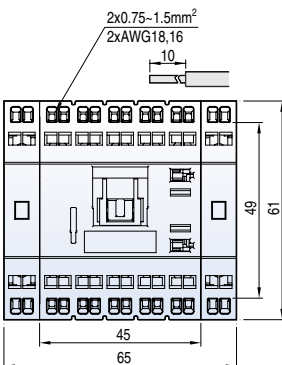

0.32kg

2-pole DC Contactors

[mm]



- SMM-30P
- SMM-30DP

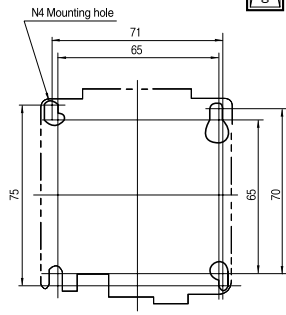
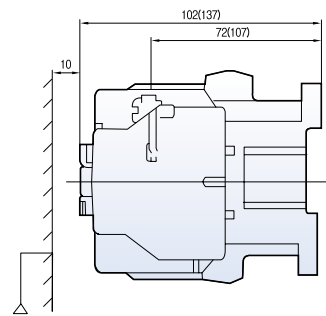
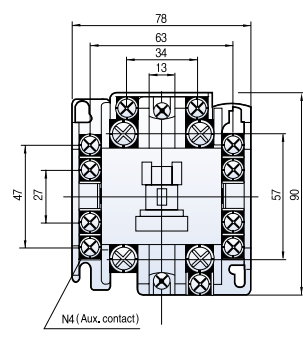

0.61(0.93)kg

- SMM-60P
- SMM-100P
- SMM-60DP
- SMM-100DP

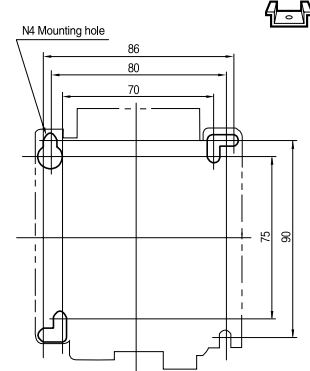
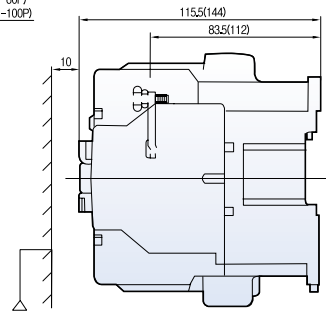
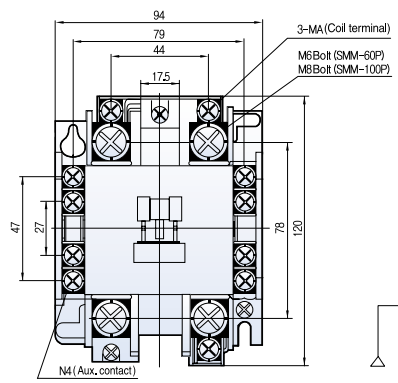

1.15(2.17)kg



Dimensions

2-pole AC Contactors

- GMC-10P2
- GMC-20P2
- GMC-25P2
- GMC-30P2
- GMC-35P2
- GMC-40P2
- (TSBS Type)

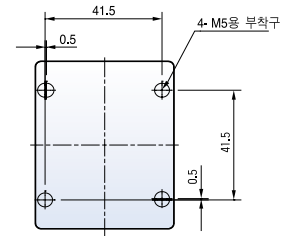
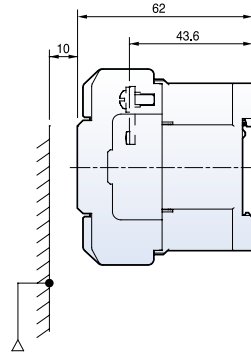
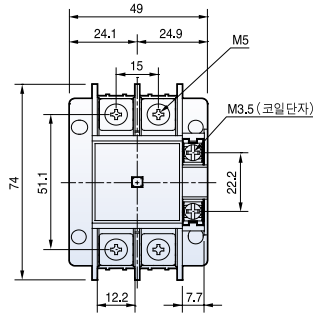

[mm]

1.29kg

- GMC-10P2
- GMC-20P2
- GMC-25P2
- GMC-30P2
- GMC-35P2
- GMC-40P2
- (TQBS Type)

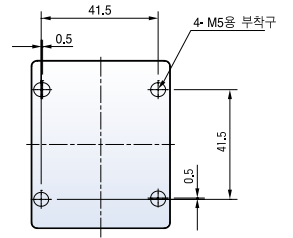
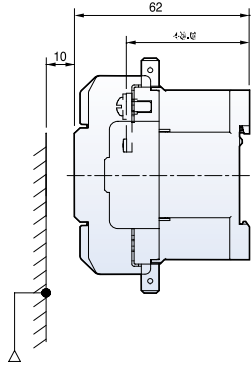
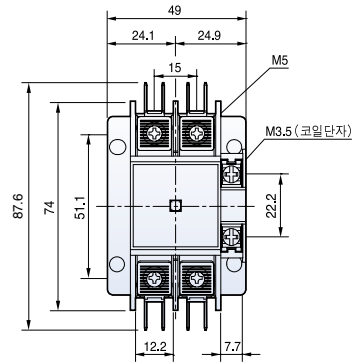

1.29kg

Circuit diagram

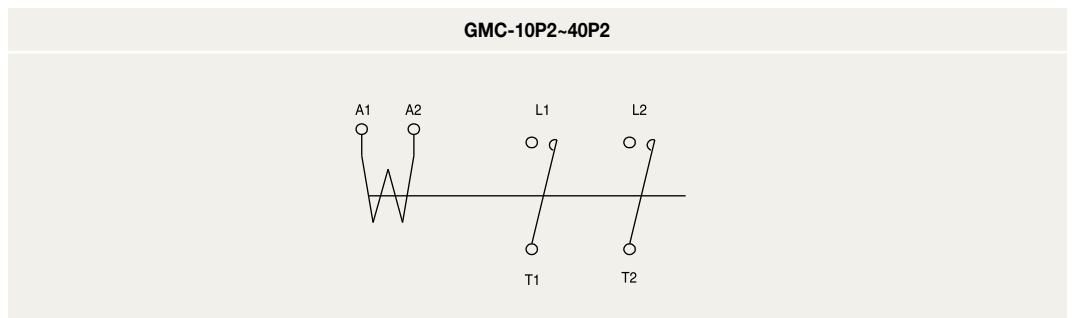

Terminal

Type	Terminal	Screw (mm ²)	Wire (kgf · cm)	Torque (mm)	A × B × C
GMC-10P2-40P2	Main	M5	1-16	26	12.2 × 7 × 8
	Coil	M3.5	1-2.5	12	7.7 × 7.5 × 4.5

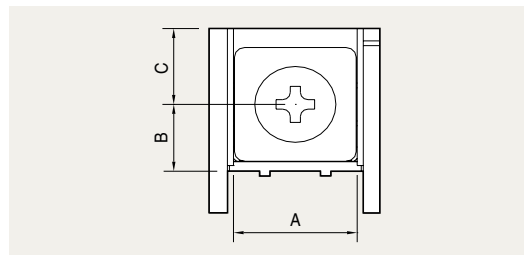

Accessories for Mini contactors

[mm]

AU-4M

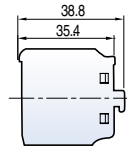
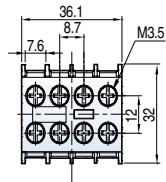

0.04kg

AU-2M

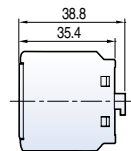
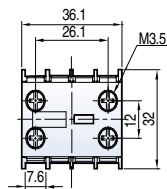

0.03kg

AU-1M

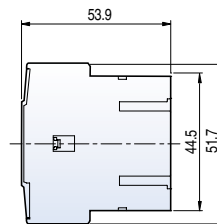
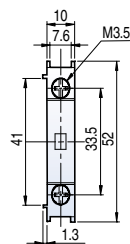

0.02kg

AT-12M

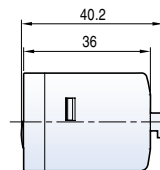
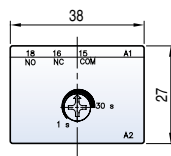

0.04kg

AS-12M

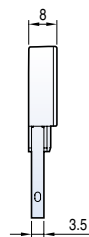
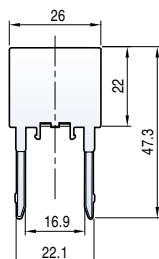

0.005kg

Green Innovators of Innovation



Safety Instructions

- For your safety, please read user's manual thoroughly before operating.
- Contact the nearest authorized service facility for examination, repair, or adjustment.
- Please contact a qualified service technician when you need maintenance. Do not disassemble or repair by yourself!
- Any maintenance and inspection shall be performed by the personnel having expertise concerned.

LSIS Co., Ltd.

© 2012.10 LSIS Co.,Ltd. All rights reserved.

www.lsis.biz

■ HEAD OFFICE

Korea Gyeonggi-do Anyang-si dongan-gu
LS-ro 127 (Hogyedong)
Tel. (82-2)2034-4887, 4873, 4148
Fax. (82-2)2034-4648

■ CHEONG-JU PLANT

Cheong-Ju Plant #1, Song Jung Dong, Hung Duk Ku,
Cheong Ju, 361-720, Korea

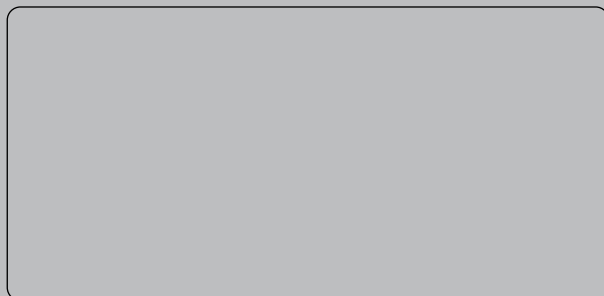

Specifications in this catalog are subject to change without notice due to continuous product development and improvement.

■ Global Network

- **LSIS (Middle East) FZE >> Dubai, U.A.E.**
Address: LOB 19 JAFZA VIEW TOWER Room 205, Jebel Ali Freezone P.O. Box 114216, Dubai, United Arab Emirates
Tel: 971-4-886 5360 Fax: 971-4-886-5361 e-mail: dhleef@lsis.biz
- **Dalian LSIS Co., Ltd. >> Dalian, China**
Address: No.15, Liaohexi 3-Road, Economic and Technical Development zone, Dalian 116600, China
Tel: 86-411-8273-7777 Fax: 86-411-8730-7560 e-mail: tangyh@lsis.com.cn
- **LSIS (Wuxi) Co., Ltd. >> Wuxi, China**
Address: 102-A, National High & New Tech Industrial Development Area, Wuxi, Jiangsu, 214028, P.R.China
Tel: 86-510-8534-6666 Fax: 86-510-522-4078 e-mail: luw@lsis.com.cn
- **LSIS-VINA Co., Ltd. >> Hanoi, Vietnam**
Address: Nguyen Khe - Dong Anh - Ha Noi - Viet Nam
Tel: 84-4-882-0222 Fax: 84-4-882-0220 e-mail: sjbaik@lsis.biz
- **LSIS-VINA Co., Ltd. >> Hochiminh, Vietnam**
Address: 41 Nguyen Thi Minh Khai Str. Yoco Bldg 4th Floor, Hochiminh City, Vietnam
Tel: 84-8-3822-7941 Fax: 84-8-3822-7942 e-mail: hjchoid@lsis.biz
- **LSIS Shanghai Office >> Shanghai, China**
Address: Room 32 floors of the Great Wall Building, No. 3000 North Zhongshan Road, Putuo District, Shanghai, China
Tel: 86-21-5237-9977 Fax: 89-21-5237-7189 e-mail: baijh@lsis.com.cn
- **LSIS Beijing Office >> Beijing, China**
Address: B-Tower 17FL.Beijing Global Trade Center B/D. No.36, BeiSanHuanDong-Lu, DongCheng-District, Beijing 100013, P.R. China
Tel: 86-10-5825-6025,7 Fax: 86-10-5825-6026 e-mail: sunmj@lsis.com.cn
- **LSIS Guangzhou Office >> Guangzhou, China**
Address: Room 1403, 14/F, New Poly Tower, No.2 Zhongshan Liu Road, Guangzhou 510180, P.R. China
Tel: 020-8326-6754 Fax: 020-8326-6287 e-mail: chenxs@lsis.com.cn
- **LSIS Chengdu Office >> Chengdu, China**
Address: Room 1701 17Floor, huamin hanjun international Building, No1 Fuxing Road Chengdu, 610016, P.R. China
Tel: 86-28-8670-3201 Fax: 86-28-8670-3203 e-mail: yangcf@lsis.com.cn
- **LSIS Qingdao Office >> Qingdao, China**
Address: Room 2001,20/F,7B40, Galaxy Building, No.29 Shandong Road, Shinan District, Qingdao 266071, P.R. China
Tel: 86-532-8501-6058 Fax: 86-532-8501-6057 e-mail: wangzy@lsis.com.cn
- **LSIS NETHERLANDS Co.Ltd >> Schiphol-Rijk, Netherlands**
Address: 1st. Floor, Tupolevlaan 48, 1119NZ, Schiphol-Rijk, The Netherlands
Tel: 31-20-654-1420 Fax: 31-20-654-1429 e-mail: junshickp@lsis.biz
- **LSIS Gurgaon Office >> Gurgaon, India**
Address: 109 First Floor, Park Central, Sector-30, Gurgaon- 122 002, Haryana, India e-mail: hwyim@lsis.biz